



---

**SCIENCE FIRST PEOPLES**  
TEACHER RESOURCE GUIDE

---

**GRADES 5 TO 9**



SCIENCE FIRST PEOPLES  
TEACHER RESOURCE GUIDE  
GRADES 5 TO 9

FIRST NATIONS EDUCATION STEERING COMMITTEE

FIRST NATIONS SCHOOLS ASSOCIATION

## Science First Peoples Teacher Resource Guide

Copyright © 2016, First Nations Education Steering Committee and First Nations Schools Association

### Copyright Notice

No part of the content of this document may be reproduced in any form or by any means, including electronic storage, reproduction, execution, or transmission without the prior written permission of FNEESC.

## Acknowledgements

### *DEVELOPMENT TEAM*

Kenneth Campbell

Jo-Anne L. Chrona, Curriculum Coordinator, FNEESC

Nancy McAleer, Belmont Secondary School, SD 62 Sooke

Noreen Pankewich, Aboriginal Resource Teacher (K-12), SD 73 Kamloops/Thompson

Raegan Sawka, Aboriginal Education Services Department, SD 52 Prince Rupert

Ellen Simmons, Head Teacher, Penticton Indian Band Education, Penticton, BC

Anne Tenning, District Vice Principal of Aboriginal Education, SD 68 Nanaimo Ladysmith

Heidi Wood, Aboriginal Education Services, SD 36 Surrey

### *CONTRIBUTORS*

Aboriginal Education Services Department, SD 52 Prince Rupert

Nadine McSpadden, Aboriginal Education Services, SD 36 Surrey

Karycia Mitchell, Belmont Secondary School, SD 62 Sooke

Robert Moxness, SD 36 Surrey

Peter Sawatzky, SD 36 Surrey

## Contact Information

First Nations Education Steering Committee

#113 - 100 Park Royal South

West Vancouver, BC

V7T 1A2

604-925-6087

1-877-422-3672

[www.fnesc.ca](http://www.fnesc.ca)

[info@fnesc.ca](mailto:info@fnesc.ca)

# SCIENCE FIRST PEOPLES TEACHER RESOURCE GUIDE GRADES 5 TO 9

## Table of Contents

Introduction	
About This Guide	4
First Peoples Pedagogy	5
Perspectives of Science	6
Indigenous Knowledge	10
Making Connections with the Community	13
Suggestions for Developing Locally-Based Resources	16
Using the Thematic Science Units	22
Assessment	24
Unit 1 Traditional Ecological Knowledge	27
Unit 2 Plants and the Connection to Place	53
Unit 3 Power from the Land	79
Unit 4 Bears and Body Systems	105
Unit 5 Climate Change	121
Unit 6 Shaking and Flooding	141
Unit 7 Interconnectedness of the Spheres	151
Unit 8 Ocean Connections	171
Supporting Learning	
Encouraging First Nations Learners' Engagement in the Sciences	191
Shared Knowledge Science Celebration	193
Bibliography	213

# INTRODUCTION

## About This Guide

With the increased inclusion of First Peoples' content in the changing BC curriculum, there is a need to incorporate unappropriated First People's perspectives into Science courses. Previously, the First Nations Education Steering Committee and the First Nations Schools Association developed teacher resources to support English Language Arts, Social Studies and Mathematics courses. This guide expands these resource materials to include Science.

The Science First Peoples Teacher Resource Guide is designed to assist science teachers in all BC schools, including First Nations and public schools. The resources focus on Grades Five to Nine, but can also be applied to other grade levels.

The guide includes background information regarding how First Peoples' perspectives in science can be recognized and included in science inquiry. It also offers curriculum planning suggestions, and provides examples of fully developed units that correspond with the Big Ideas and Learning Standards in the BC Provincial Science Curriculum for grades 5- 9.

This guide is intended in part to address the Calls to Action of the Truth and Reconciliation Commission, particularly the call to “integrate Indigenous knowledge and teaching methods into classrooms” (clause 62) and “build student capacity for intercultural understanding, empathy and mutual respect” (clause 63).

## Goals of the Science First Peoples Teacher Resource Guide

- to contribute to Reconciliation for all by building greater understanding of the skills, knowledge and perspectives of First Peoples for all students
- to provide resources to enable teachers to incorporate First Peoples' perspectives into the teaching and learning of the sciences
- to ensure the inclusion of First Peoples' perspectives is done respectfully and without appropriating First Peoples' knowledge.
- to implement strategies to enhance First Nations students' participation in the sciences
- to encourage and support the respectful development of local resources
- to reflect the connection with the land on which we are all situated

## First Peoples Pedagogy

These learning resources are guided by the recognition of ways of learning inherent in First Nations' world views. While each First Nation has its own unique identity, values and practices, there are commonly held understandings of how we interact and learn about the world. In respect of these, the activities in this guide:

- are learner centred
- are inquiry based
- are based on experiential learning
- emphasize an awareness of self and others in equal measure
- recognize the value of group processes
- support a variety of learning styles

The activities are based on the following principles which reflect a respectful and holistic approach to teaching and learning and are an example of Indigenous Knowledge. They were first articulated by a diverse team of Indigenous educators, scholars and knowledge-keepers during the development of English 12 First Peoples.

### First Peoples Principles of Learning

Learning ultimately supports the well-being of the self, the family, the community, the land, the spirits, and the ancestors.

Learning is holistic, reflexive, reflective, experiential, and relational (focused on connectedness, on reciprocal relationships, and a sense of place).

Learning involves recognizing the consequences of one's actions.

Learning involves generational roles and responsibilities.

Learning recognizes the role of indigenous knowledge.

Learning is embedded in memory, history, and story.

Learning involves patience and time.

Learning requires exploration of one's identity.

Learning involves recognizing that some knowledge is sacred and only shared with permission and/or in certain situations.

## Perspectives of Science

There are many ways to view science, many ways to look at and understand the world, as these statements illustrate:

“Science is about the pursuit and delving into the unknown.” Dr. Leroy Little Bear. Indigenous Knowledge and Western Science: Dr. Leroy Little Bear Talk, Banff Centre. (<https://www.youtube.com/watch?v=gJSJ28eEUjI>)

“Science is the pursuit and application of knowledge and understanding of the natural and social world following a systematic methodology based on evidence.” UK Science Council website (<http://sciencecouncil.org/>)

“Science is curiosity in thoughtful action about the world and how it behaves.” NASA website (<http://spaceplace.nasa.gov/science/en/>)

“Traditional Knowledge is science.” George Hobson, Canadian scientist. (<http://www.carc.org/pubs/v20no1/science.htm>)

“Science is experiment, science is trying things. It is trying all possible alternatives in turn, intelligently and systematically, and throwing away what won't work and accepting what will.” R. Doyle. The Nature of Science. *Bridges*. October, pp 12-16, 1985.

“Science is ... a rational, empirically based description–explanation of nature. This concept includes, among others, the Eurocentric cultural perspective (Western science) and Aboriginal cultural perspectives (Indigenous knowledge) held by First Nations, Inuit and Métis peoples in Canada.” Glen S. Aikenhead. Towards Decolonizing the Pan-Canadian Science Framework. *Canadian Journal of Science, Mathematics and Technology Education*, v 6 n 4. 2006.

In bringing First People's perspectives to the classroom, we can consider three different approaches to science and find ways they can converge.

**Indigenous Knowledge** is the knowledge of Indigenous peoples, including scientific and evidence-based knowledge, that has been built up over thousands of years of interaction with the environment. It is holistic knowledge rooted in place and contained in language.

**Contemporary Science** is an evidence-based way of understanding the natural world. Asking questions and discovering answers results in a continuous revision of knowledge. Scientific knowledge is provisional and influenced by culture, beliefs and ethics.



## INTRODUCTION

**School Science** encompasses both what is considered important to teach and learn in K-12 schools, and how science is taught. Ideally, it incorporates scientific curiosity and inquiry.

### CONVERGENCE

Indigenous Knowledge and contemporary Western Science are complementary ways of knowing about the world, and today they have in many ways converged in modern scientific practice. However, some school science has been left behind by not being part of the convergence.

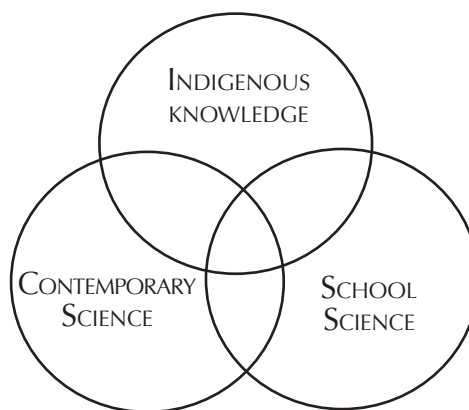

There are many examples of contemporary science validating Indigenous Knowledge. Take the recent DNA studies that shows a direct genetic link between Ts'msyen people living at Metlakatla BC today with bones recovered from a nearby archaeological dig that are 5500 years old.<sup>1</sup> Underwater archaeology on Haida Gwaii has found evidence that people lived there more than 12,000 years ago.<sup>2</sup>

Contemporary science is moving towards a more holistic vision of nature, in accordance with Indigenous thought. For example, in July 2012 The Cambridge Declaration of Consciousness was made by leading neuroscientists who declared that animal and human consciousness are on the same level. This and other discoveries substantiate the interconnectedness of all things.

In another example, UBC forestry scientist Dr. Susanne Simard discovered that trees communicate with each other in the forest through sophisticated fungal networks. She also helped identify Mother Trees, large trees which act as hubs for a vast network of young trees and seedlings.

In environmental science, Traditional Ecological Knowledge is very important for scientists developing baseline data. Where scientific data about the behaviour of a certain species may only go back thirty years when scientific recording began, traditional knowledge can take it back generations. As well, it is a crucial indicator of how well resource management strategies are working, as Indigenous people observe changes in their local ecosystems.

Integrating traditional knowledge and contemporary science is seen as vitally important in working to achieve sustainability in our use of resources and bringing balance back to our ecosystems that have been impacted by modern society.

---

1 <http://news.nationalpost.com/news/canada/groundbreaking-genetic-study-links-living-first-nation-woman-to-5500-year-old-ancestor>

2 <http://www.ancient-origins.net/news-history-archaeology/13800-year-old-haida-site-found-underwater-canada-002485>

## *INTRODUCTION*

School science, on the other hand, is sometimes seen as prescriptive, based solely on facts to be learned. It often projects the view that what is important in the world has already been discovered. The knowledge that is transmitted is most often based in Western worldviews.

Today we have the opportunity to bring school science into convergence with Indigenous Knowledge and Contemporary Science through a broader understanding of what Indigenous Knowledge is and how it can be infused into the classroom.

### What is Science?

#### Perceptions and Experiences of Aboriginal Students who are Successful in Senior Secondary Science

##### Student Science Definitions

Science is

"A method of understanding and postulating the world. It is a social construction and its theories are not proven."

"The study of living and non-living organisms of life."

"The study of humans and animals into great depth exploring all aspects of life and life's effectors."

"The study of all things that make up our world and making the unknown, known."

"The discovery of new forces, organs, etc."

"The thing that explains everything."

"A group process to find a conclusion to a hypothesis."

"The study of the world around us and how things interact."

"A way to understand the world we live in and easily share this knowledge with others, thus contributing to a greater global knowledge."

"A means by which to gather knowledge systematically."

##### Student Metaphors for 'Science'

*If science was an animal, what would it be and why?*

"Science is like a squid or a jellyfish because they have spawn off, they have lots of arms and science is at the centre, they are multi-limbed."

"Science is like a monkey - monkeys are always interested in everything that's around them and so they always have to examine things and I just find science does that too examines organisms or anything like that."

"Science is like a whale – it's one of the biggest animals and science, it's a pretty broad topic. It can go into lots of different things and it's versatile. Also it's big but there's lots of little intricate things about a whale as well same with science – different branches you can go into."

"Science is like a lion. It kind of came with everything. Science is really powerful to humanity and lions are the king of the jungle."

"Science is like a bear because science is very tough and a bear is very tough. It's kind of hard to get past [science] but once you get started, you can do it and finish it and get past the bear after awhile too, once you stop being afraid of it, you can just walk by it."

*If science was an object, what would it be and why?*

"Science is like a mountain because it is born of the earth, it gets bigger and bigger – part of a cycle trying to move towards a peak of knowledge; it would crumble back or it is continuously being reviewed – a circle kind of."

"Science is like a fridge because it has its boundaries. You can just look at it and it's a fridge or it's science and then when you open it up, you find lots of different things and everyone has their own things in it."

"Science is like a home. I feel comfortable in science. I just never felt puzzled by science."

"Science is like a bike. Once you start learning how to ride a bike, you don't know how at the beginning and you're scared then you start riding it and it gets easier. If you try your hardest at science, you could just roll through it and finish."

Source: Anne Tenning. *Metaphorical Images of Science: the Perceptions and Experiences of Aboriginal Students who are Successful in Senior Secondary Science*. Masters Thesis UVIC 2010. Used by permission.

## Indigenous Knowledge

What is Indigenous knowledge, and how can it be brought into science classes? This section looks at important concepts in understanding Indigenous knowledge, the importance of Interconnectedness, Sense of Place, Language, Place Names, Story and Traditional Ecological Knowledge.

### *INTERCONNECTEDNESS*

First Peoples are diverse, and the unique knowledge each group holds is part of their individual worldviews. However, they share a common belief that we are all connected to nature and to each other. This notion that we are all connected with everything in the world is expressed by many First Peoples in the phrase “All my relations.”

Inherent in this view of the world is the understanding that everything in the universe has a place there and deserves respect. From this vantage point, people view their relations with others as well as the natural world differently than someone who only sees it through a microscope or telescope.

### *SENSE OF PLACE*

Connection with place, with the land, is the foundation of Indigenous Knowledge. This means that each Indigenous group holds unique world views, technologies and pedagogies according to their environment and territories. Indigenous knowledge, passed on through the generations, was essential for survival. Survival for First Peoples depended on and depends on their particular knowledge of the land, their unique relationship with the environment, and their shared values and practices through which they made sense of the world.

The concept of Place goes far beyond the physical space. It includes a crucial Sense of Place, the memories, emotions, histories, spiritualities that bind the people to the land.

Five concepts of place have been identified, common to most First Peoples<sup>3</sup>:

- Place is multidimensional. More than the geographical space, it also holds cultural, emotional and spiritual spaces which cannot be divided into parts.
- Place is a relationship. All life is interrelated.
- Place is experiential. Experiences a person has on the land give it meaning.
- Place is local. While there are commonalities, each First Nation has a unique, local understanding of Place.
- Place is land-based. Land is interconnected and essential to all aspects of culture.

Making connections with place in science curricula is an integral part of bringing Indigenous science into the classroom. That means including experiential learning in local natural and cultural situations.

<sup>3</sup> Adapted from Michell et al., *Learning Indigenous Science From Place*, p. 27-28.

## INTRODUCTION

### LANGUAGE

Language is the vessel that contains Indigenous knowledge. Understanding is embedded in language, and knowledge is structured and transmitted through language. Learning through oral language is part of its experiential nature.

Through the processes of colonization, First Nations languages have undergone attack. Most communities suffered significant language loss, and one of the results of the loss of language is the loss of knowledge. As well, learning has moved from the oral to the written.

Some languages face extinction, but others are experiencing renewal. People are working to revitalize languages which in turn will serve to keep traditional knowledge alive.

Like most languages, strong Indigenous languages continue to grow and sometimes new words have been added to the language for contemporary objects. For example, in the Ts'msyen language Sm'algyax, the word flashlight is *laawksm ts'amti* (light lightning or lightning from a light). In Tsilhqot'in, the word for helicopter is *bet'sit'ay naghedalt'ex* (Something that has something spinning on top of it.)

Incorporating traditional languages into experiential science activities wherever possible is an important part of bringing Indigenous Science into the classroom. There may be local community language resources in the school or community to support this. An online source that students can access is [firstvoices.com](http://firstvoices.com) which gives students searchable vocabularies in many of BC's diverse First Nations languages.

### PLACE NAMES

Traditional place names provide information about First Peoples and their relationship with the land. Traditional knowledge is often embedded in place names. Paying attention to the name of places in traditional territories can lead to a wealth of information about local ecosystems, land use or plant and animal behaviour.

Many First Nations communities have documented the traditional place names of their traditional territories and they may be available as a classroom resource. However, some place names may be considered private and to be used only by community members.

### STORY

Story is one of the main methods of traditional Indigenous learning and teaching. Combining story and experience is a powerful strategy that has always been used by First Peoples, and its power can also be brought to the science classroom.

## INTRODUCTION

Stories enable holistic learning. They meld values, concepts, protocol, practices and facts into a narrative. They also develop important skills of listening and thinking.

Story can be an important part of the science curriculum. Oral storytelling can be incorporated by inviting First Nations storytellers into the class, or the teacher can read a written version of a traditional story where appropriate. Reading published stories that are relevant to the science class can integrate with English Language Arts, or where First Nations languages are taught.

### *TRADITIONAL ECOLOGICAL KNOWLEDGE*

Traditional Ecological Knowledge, or TEK, is the most popular term to denote the vast local knowledge First Peoples have about the natural world found in their traditional environment. As with the definition of science, there are differing meanings of TEK. Sometimes the term is expanded as Traditional Ecological Knowledge and Wisdom. Other terms used are Aboriginal Traditional Knowledge, Naturalized Knowledge Systems, local knowledge, and Indigenous Knowledge. Some view TEK as a construct of other contemporary sciences. Others fear the word “traditional” suggests the knowledge is stuck in the past, where in fact it is dynamic and continually being renewed.

TEK is widely used in biological and environmental sciences, and is largely considered to be complimentary to, and equivalent with, Western scientific knowledge. The environmental knowledge of generations is important to fields such as resource management, climate change and sustainability. For example, at the federal level, an ATK subcommittee reports to the Committee on the Status of Endangered Wildlife in Canada which make recommendations to the Minister based on TEK in their own local regions on species that may need to be listed.

TEK is, above all, local knowledge based in people’s relationship to place. It is also holistic, not subject to the segmentation of contemporary science. Knowledge about a specific plant may include understanding its life cycle, its spiritual connections, its relationship to the seasons and with other plants and animals in its ecosystem, as well as its uses and its stories.

It is important to recognize that TEK is the intellectual property of the First Nations who hold it. Many people share much of their knowledge with others, but there is other knowledge and wisdom that is considered private and is not shared.

## **Making Connections with the Community**

Bringing First Peoples perspectives of science into the classroom means in part connecting with the local First Nations community. It is important to understand and practice the local protocols in areas such as:

- Inviting Elders and other knowledgeable community members into the classroom to speak
- Respecting the natural world when going out on field trips
- Visiting First Nations lands and territories
- Interviewing people
- Holding special events such as a celebratory feast
- Developing science units

Most communities have protocols in place to be followed when working with Elders and Knowledge Keepers. This may include showing respect by offering a gift to the person, or perhaps to the land when on a field trip.

Make contact with the local First Nations communities through workers in schools or through the local Band Council. There may be a School District staff member such as an Aboriginal District Principal, Aboriginal Helping Teacher, Resource worker or other liaison person to help with the initial contact. Guidance can be sought from local learning centres and community organizations such as Friendship Centres, First Nations offices, Tribal Councils or cultural centres.

It is important to work with the appropriate agencies to make sure that certain Elders and Knowledge Keepers do not get over-worked or called upon too often.

All knowledge shared by local First Nations is inherently their intellectual property. FNEESC is developing intellectual property agreement and policy templates to support First Nations in protecting community ownership of traditional knowledge and language when entering into educational partnerships. Watch the FNEESC publications page for updates.



## First Peoples Guest Speaker Considerations<sup>4</sup>

It is important to follow protocols when inviting a member of a First Nations community or Aboriginal organization to a classroom or school. Below are some general considerations and processes. There are also often protocols specific to local communities. School district Aboriginal education departments or community education departments can also provide guidance regarding those specific protocols.

These considerations can also be adapted when taking students on field trips or into field learning experiences that will be led by, or facilitated by, a member of a First Nations community or Aboriginal organization.

### *BEFORE THE VISIT*

- Determine the purpose of the visit (how it is connected to the curriculum or learning standards for the class or course). If it is not directly connected to the curriculum, be clear about the intended learning standards so that the guest visit is meaningful experience for all involved.
- It is a culturally appropriate protocol for guest speakers to be provided with a gift and/or honourarium for sharing their time and knowledge.
  - Consult with the school district’s Aboriginal education department or First Nations community to determine the appropriate amount or gift (if the speaker has not already indicated an amount for an honourarium).
  - Determine where funds will come from in advance. Check to see if the school or PAC can contribute.
  - If the school and/or school district requires any paperwork to be completed before payment can be issued, ensure that this is done well in advance of the visit so that payment can be issued at the time of visit or as soon as possible afterward.
- Talk with the speaker about the details of the visit:
  - Date and time of the visit
  - The course and grade levels of the students
  - Approximate number of students
  - Let the speaker know what content/learning has led up to the visit.
  - Ask the speaker about any specific needs:
    - Are there any hand-outs that need to be photocopied in advance, or any equipment or supplies needed?
    - Is there any specific information that students should know before the visit?
    - Are there any specific protocols that the students and adults need to follow during the visit?
    - Is there is anything else that will help make the visit more comfortable for

---

<sup>4</sup> Adapted by permission from an original document by Anne Tenning, School District 68 Nanaimo-Ladysmith



## INTRODUCTION

- the speaker (especially if it is an Elder)?
  - Would it help to have the classroom/space organized in a specific way?
  - Ask for permission to take photos or videotape (if desired).
  - Ask the speaker for some background information that can be used to introduce the speaker to the students (for example, where the speaker is from, his or her role or occupation, noteworthy experiences or accomplishments).
- Arrange arrival details:
  - Ensure everyone knows where the speaker will be met.
  - For example, arrange to have the speaker met in the parking lot, at the front door of the school, or in the main office.
  - In some situations, the speaker may need transportation from home.
  - If possible, include students in the greeting.
- Ensure the students are prepared prior to the visit:
  - Connect speaker's visit to students' previous learning
  - Review respectful behaviour with students, including non-verbal communication
  - Model for students how to introduce themselves
  - Brainstorm with students questions that they can ask
  - Prepare students to provide a thank-you to speaker
- Ensure office staff and administrators know that a guest is expected.

## DAY OF VISIT

- Prepare physical space of classroom. Set up any necessary equipment.
- Welcome guest, offering water/tea/coffee. Let them know where washrooms are located.
- Introduce speaker to students and if appropriate do acknowledgment of territory.
- If students will be introducing themselves to the speaker, consider a talking circle format, saying name and where they are from.
  - Ensure there is time for questions/discussion at the end of the session.
  - Have student(s) formally thank the speaker and present gift or honourarium.
  - If possible, debrief the session with speaker.
  - Walk the guest out.

*\*It is important that the teacher stay present for the session as this models for the students a valuing of the knowledge and time of the speaker. If any behavioural challenges occur, it is the teacher's responsibility to address them, not the speaker's.*

## AFTER THE VISIT

- Debrief the session with the students.
- Do follow-up activity with students.
- Have students follow up with thank-you letter.
- Touch base with speaker to ensure that honourarium was received (if not presented on day of session).

## Suggestions for Developing Locally Based Resources

This guide gives sample units which incorporate Indigenous Science perspectives into science activities. Teachers are encouraged to develop local units that speak to the local sense of place and non-appropriated knowledge of local First Nations, in collaboration with knowledgeable community members.

Below are a number of suggestions for developing local inquiry based, experiential lessons which can integrate with the BC Curriculum.

### *WORKING IN PARTNERSHIP WITH COMMUNITY MEMBERS*

Great success comes from working in collaboration with the local community. Here are some fundamental considerations when consulting with community members.

- Develop classroom resources in collaboration with Elders, knowledge keepers and other community members.
- Approach the community members with respect.
- Prepare to consult with community members by reading published or online resources relating to your topic to get an idea of local knowledge.
- Explore ways to allow students to get out onto the land and to experience the “place” of the local First Peoples.
- Remember that not all knowledge can be, or will be, shared. This needs to be respected.
- All cultural knowledge remains the copyright of the community. Educators, schools and/or school districts should not attempt to copyright lessons developed in collaboration with First Nations communities.
- How you connect with the local First Nations community will depend on your school and location.
  - Most school districts have a District Aboriginal Principal or similar position who may be able to connect you with community members.
  - Band operated schools have an education coordinator or other band council member whose responsibility is liaison with the schools.

## INTRODUCTION

### *FRAMEWORK FOR DESIGNING INDIGENOUS SCIENCE RESOURCES*

On pages 18 and 19 is a rubric illustrating a framework for designing Indigenous science resources. It was developed by, and reprinted with the permission of Dr. Judy Thompson. Some fundamental aspects for involving Indigenous science include:

- Indigenous Voice. What cultural experts can contribute to the unit implementation?
- Indigenous Languages. How can the local First Nations languages be included in the lessons?
- Diversity of Indigenous Groups. Do the lessons recognize the diversity of First Nations? Can the unit be shared and adapted to other groups?
- Protocol. What protocols need to be followed during the implementation of the unit?
- Relationship with the Land. How can the unit reinforce the importance of the land, plants and animals to Indigenous people?
- Ways of Learning, Ways of Teaching. Are traditional ways of learning included? Are activities student centered? Is evaluation formative?

### *7E MODEL*

The 5E model<sup>5</sup> has been widely used as a structure for developing experiential learning activities for science. This model can be expanded to include two significant components that incorporate Indigenous science: Environment and Elders. It can be used to structure a single lesson, or a over a number of days. It works well as an organizer for inquiry learning. See Shared Knowledge Science Celebration, page 193.

#### Environment

Situate the lessons in the local land and environment. This builds an appreciation for the concept that everything is connected to everything else and taps into a sense of Place.

#### Engage

Capture student attention and curiosity. Raise scientifically relevant questions. Connect what students know with a new question or idea. Ask a question, show something interesting, pose a problem.

#### Explore

Experiential. Students observe, record, connect ideas, ask questions, usually in groups. Teachers are coaches and facilitators.

(7E Model continued on page 20)

---

<sup>5</sup> 5E model developed by Biological Sciences Curriculum Study in 1987. See <http://bscs.org/bscs-5e-instructional-model>.

## Framework for Designing Indigenous Science Resources

<i>Criteria</i>	<i>Gradations of Quality</i>			
	<i>4</i>	<i>3</i>	<i>2</i>	<i>1</i>
<i>Indigenous Voice</i>	Cultural experts are a significant and critical part of unit implementation. Elders and community members are involved at all stages of the curriculum development process and an Indigenous person is directly involved in the writing of the curriculum.	Cultural experts are involved. Elders and community members have been involved in many stages of the curriculum development process.	Cultural experts have been involved, but their role is not clear.	Involvement of cultural experts not mentioned.
<i>Indigenous Languages</i>	Indigenous languages are recognized as being an integral part of Indigenous ways of knowing and worldview. The language plays a large part in the lessons and activities.	Indigenous languages are recognized as being an integral part of Indigenous ways of knowing and worldview. While the language does not play a large part in the lessons, the importance of learning the language from Elders and other fluent speakers is stressed.	No mention of the importance of Indigenous languages to Indigenous ways of knowing and worldview but there are Indigenous words used here and there throughout the curriculum.	Indigenous languages are not part of the curriculum and there is no mention of their importance to Indigenous ways of knowing and worldview.
<i>Diversity amongst Indigenous Peoples</i>	Focus of curriculum is on one particular Indigenous group. The curriculum is flexible enough so that it can be adapted to other Indigenous groups.	Focus of curriculum is on one particular Indigenous group. There is not much flexibility in the lessons so that they cannot be adapted to other Indigenous groups.	Curriculum is very general and is not focused on any particular Indigenous group. However, it does make reference to the diversity amongst Indigenous groups.	Curriculum is very general and is not focused on any particular Indigenous group. Does not make reference to the diversity amongst Indigenous groups.

Adapted from: Appendix F, pp. 136-140. Thompson, J.C. (Edösdí), (2004). *Gríga*: at Plant Project: The Intergenerational Transmission of Traditional Plant Knowledge Using School Science Curricula. (Unpublished Master's Thesis). University of Victoria, Victoria, BC.

INTRODUCTION

<b>Protocol</b>	It is recognized that when working with specific Indigenous communities and cultural experts that there are protocols to be followed. These are explicitly stated.	It is recognized that when working with specific Indigenous communities and cultural experts that there are protocols to be followed. These are not stated, but are directed to individuals and/or organizations (e.g. hereditary chiefs, band council members, educators, etc.) in order to find out the proper protocol to be followed.	The importance of following protocol is not highlighted, but individuals and/or organizations within the community are listed as contacts for general information.	There is no mention of the importance of following protocol.
<b>Relationship with the Land</b>	States the importance of the land, plants and animals to Indigenous peoples. Lessons either take place out of the classroom on the land (e.g. at fish camps, seaweed camps, etc.) or in the classroom. Cultural experts are integral to the lessons.	States the importance of the land, plants and animals to Indigenous peoples. While some lessons take place out of the classroom on the land, many of the lessons take place in the classroom. Cultural experts are often involved.	Does not state the importance of the land, plants and animals to Indigenous peoples. Most of the lessons take place in the classroom but cultural experts are brought in once in a while.	Does not state the importance of the land, plants and animals to Indigenous peoples. Lessons take place inside a classroom without the involvement of cultural experts.
<b>Ways of learning, ways of teaching</b>	Traditional ways of learning and teaching are outlined. Activities are numerous and varied and are student-centred. They often take place on the land with Elders (observation, practice, participation, active involvement, etc.). Learning and evaluation ideally take place at the same time; is formative.	Traditional ways of learning and teaching are mentioned. Several activities take place, such as videos, guest speakers, field trips, guided labs, non-directed labs. Lectures are limited and teacher acts as a facilitator. Evaluation is a balance of formative and summative.	Traditional ways of learning and teaching are not mentioned. Some activities, such as videos or guided labs. Evaluation is a balance of formative and summative.	Traditional ways of learning and teaching are not mentioned. Activities are teacher-centred (lecture oriented). Evaluation is summative.

## INTRODUCTION

### Elder

Elders and other knowledgeable community members represent the Traditional Ecological Knowledge held by the community. They can connect the science activities through sharing their traditional knowledge. Where Elders or other knowledge keepers are not available, students may consult other authentic and appropriate cultural resources such as video, print and online sources.

### Explain

Describe observations and come up with explanations. Develop vocabulary, apply and interpret evidence. Students reflect on their processes, thinking and conclusions. Teachers guide students with questions and suggest additional resources.

### Elaborate

Use information to extend learning to new situations. Make connections to their personal lives and to society. Teachers help students broaden understanding.

### Evaluation

Students demonstrate their understanding of concepts and skills learned. Teachers ask open-ended questions and encourage students to self-assess their learning.

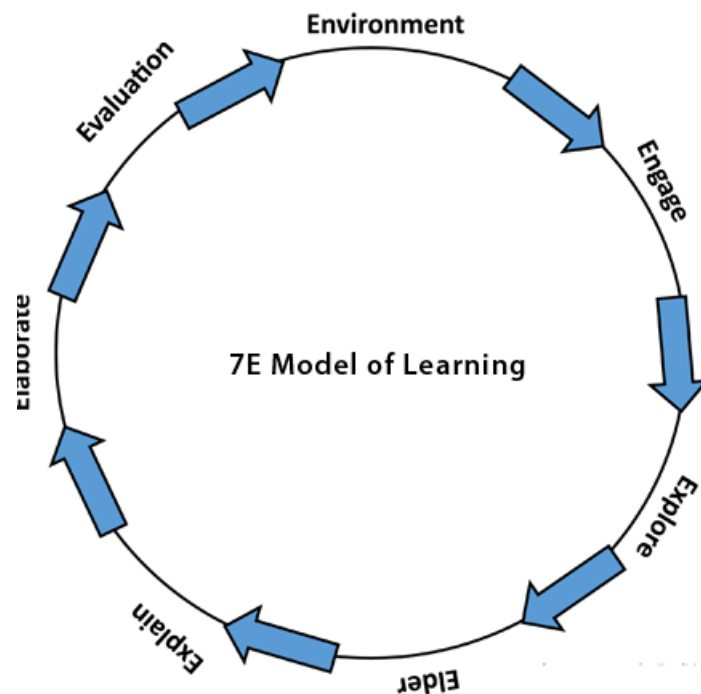



## INTRODUCTION

### *ENCOURAGING INQUIRY*

Inquiry-based learning fits well with the First Peoples pedagogy discussed above, and the First Peoples Principles of Learning. It also supports the goals of the 2016 BC Science Curriculum.

Through an inquiry approach to the study of First Peoples scientific and traditional knowledge, students and teachers can learn together to connect new ideas with the following.

### **Characteristics of Inquiry-based Learning**

Here are some of the characteristics that teachers can incorporate into their classrooms when using inquiry:

- **student driven**, allowing them to make decisions and take responsibility for their learning
- **rooted in the big ideas** set out in the curriculum; teacher's role is to connect the ideas with the interests and ongoing questions of students
- **authentic** learning opportunities to explore real life experiences based on curricular expectations
- **encourages reflection** on learning; students discuss daily why, how and what they are learning
- **patience and time**; students are given the time needed to explore their ideas and thinking
- **teachers model** how to question, plan, observe and reflect
- **teachers intervene** at appropriate moments to make sure all students understand the concepts and processes, and are engaged in the activity
- **direct instruction** occurs when needed, when students need certain information to move forward

### **The Inquiry Process**

Inquiry is a circular and fluid process. It may be helpful to consider these four stages of inquiry:

- **Focus:** Activities provide a provocation, spark or experience to engage students; develop big ideas, questions or topics
- **Explore:** Students investigate, gather information, connect thinking to prior knowledge, record information and add samples of work to portfolios
- **Sharing Learning:** students answer and refine questions, communicate findings, reflect on their learning, extend learning
- **Analyze:** Students draw conclusions, test hypotheses, summarize and create new questions and hypotheses, which can then lead back to the other phase

## Using the Thematic Science Units

The materials in the Teacher Resource Guide are meant to be a beginning or starting place for educators. They are not comprehensive, and hold only a sample of BC First Peoples' scientific knowledge. There are diverse First Nations communities in BC speaking over thirty languages, living in myriad different ecosystems from the desert of the Okanagan to rainforests of the coast. Each has its own unique body of knowledge special to its local territories.

The units can and should be used in conjunction with locally developed resources. A richer curriculum results when you connect with your local community, as there is significant diversity of cultures and languages between communities, and there is much knowledge that is locally held.

The eight units in this Teacher Resource Guide provide a variety of learning activities and resources for teachers to adapt to their own lesson planning. The activities are intended to be flexible in their use. Although the first activity is usually an introduction to the topic, the activities are not necessarily meant to be taken sequentially. It is not expected that a teacher would use all the suggested activities.

The units are designed to be embedded in the BC Science curriculum, but they also offer many opportunities for cross-curricular planning.

The units are organized as follows:

### **Introduction**

A general introduction to the focus of the unit and important background information.

### **First Peoples' Connections**

A discussion of some of the key concepts and issues in the theme that pertain to First Peoples cultures.

### **Planning to Teach the Unit**

An overview of the goals of the unit and options for teachers to plan their lessons, including:

### Outline of Activities

### Enduring Understandings and Essential Questions

These guiding understandings and questions embody the core concepts, issues, problems or theories that are at the root of the activities. They ensure that Indigenous perspectives are at the centre of the activities.



## INTRODUCTION

### Curriculum Connections

Each unit includes a table of Suggested Topics and Inquiry Questions, with suggested Learnings Standards from the BC Science Curriculum for Grades 5 to 9, including Curricular Competencies and Content.

### Cross Curricular Links

These list some suggestions for extending the topic into other subject areas.

### **Suggested Resources**

This list summarizes the essential materials and resources that will be needed to carry out the activities.

### **Suggested Activities**

The activities have been developed with a flow or sequence, but are intended to be flexible and adaptable. Generally they begin with introductory activities which in many cases ground the topic in the personal and local. Later activities build on knowledge and skills learned in earlier activities

### **Assessment**

Most assessment will depend on the activities teachers incorporate into their lessons. This section provides suggestions for assessing the Essential Questions for each unit, providing a broad type of assessment.

For a further discussion of types of assessment that can be used for inquiry-based lessons, see the next page.

### **Additional Resources**

At the end of each unit there is a list of suggestions for relevant additional books, videos and web sites for students and teachers to use. All resources mentioned are also listed in the Resources section following the Thematic Units.

### **Blackline Masters**

Teaching resources that are ready to be photocopied for student use.

## Assessment

Teachers are encouraged to use a variety of formative assessment strategies, in keeping with the First Peoples Principles of Learning and inquiry models.

### *FORMATIVE ASSESSMENT STRATEGIES*

Formative assessment is assessment for learning by providing ongoing feedback to students, and at the same time allowing teachers to tailor instruction to the needs of students or groups. It is embedded in regular instruction and inquiry.

A variety of formative assessment strategies can also help document students learning, and be part of their ongoing portfolio of student work.

#### 1. Informal Questioning

By asking timely and thought-provoking questions, teachers can informally assess students' understandings of concepts and processes and also guide their learning.

- Questions can focus students' reflection on the concepts, skills, goals and processes involved in an activity, providing teachers with information about their learning before, during, and after an activity or step in an inquiry.
- Most questioning, being timely, will be undocumented, but checklists could be used to assess certain concepts, skills or processes.

#### 2. Performance Task

Performance tasks are used both to teach and assess. They may consist of a single task or a set of tasks.

- Students communicate their understanding of skills and concepts through a variety of modes: active demonstration, text, images, or models.

#### 3. Graphic organizers

Students can represent their learning in a visual way using a variety of graphic organizers. Examples of graphic organizers include:

- Concept Map
- Compare/Contrast
- KWL
- Venn Diagram
- Classifying Chart
- Cause and Effect
- T-Chart
- Story Board
- Sequencing Chart
- Topic/Subtopic Web

#### 3. Rubrics or other scoring tools.

- Depending on the activity, teachers, students or both together can develop criteria to be assessed. They can be used for assessing understandings of concepts, project or reports, self assessment or peer assessment.

## INTRODUCTION

### 4. Journals and Portfolios

- Provide students with relevant topics or cues for their reflective journaling.
- Assess informally during the course of classwork.
- Have students assess their journals and portfolios at the end of the unit. Ask them to identify 5 or 10 sections that seem to be the most important for their learning.

### 5. Projects and Presentations

- Self and peer assessment can be used. Students can help set out the criteria for assessment.

## SUGGESTIONS FOR QUESTIONING DURING THE 7E PHASES

### Environment

- What is special about the place we live? (in the context of the topic under study)
- How might place help you to think about the topic we're going to explore?
- What do you wonder about the place where we live?

### Engage

- What do you already know, and what would you like to know about the topic, issue or idea? (KWL strategy could be used)
- Ask students questions that will help you to assess the level of students' understanding.
- Ask students questions that can lead to clearing up misconceptions in students' background knowledge.

### Explore

- What is the big idea you want to explore?
- What questions do you have about this big idea?
- What one or two inquiry questions will you focus on?
- How will you go about investigating your question?

### Elders

- How did working with Elders, cultural experts or other cultural sources add to your understanding of your question?
- Did you find out any relevant words or phrases from the local First Nations language?

## INTRODUCTION

### **Explain**

- Ask questions that allow students to explain the processes they followed in their inquiry.
- Ask questions that enable students to connect their explanations with scientific knowledge and Traditional Ecological Knowledge.

### **Elaborate**

- Help students develop new questions.
- Ask questions that guide students to apply their learning in new ways.

### **Evaluation**

- Ask students questions that provide opportunities to show that they understand the key concepts studied.
- Ask questions that enable students demonstrate their learning progress.

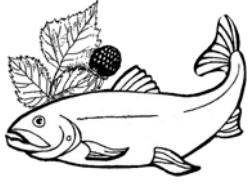

# UNIT 1

## TRADITIONAL ECOLOGICAL KNOWLEDGE

### Introduction

We all have local knowledge that we use to go about our daily life. It varies greatly depending on the place we live. For some it might include knowing how to fix a skidoo when it breaks down; for others it may be knowing how to navigate a subway system.

Part of this knowledge, or understanding of the world, is Ecological Knowledge. We all have a sense of how we connect with the natural world, be it limited or expansive. Some we learn through family, some through experience.

For Indigenous peoples around the world, whose survival depended and still depends on their relationship with the land, Ecological Knowledge is everything. Without a great depth of knowledge about the land and all its resources, survival would not be possible. This knowledge is called Traditional Ecological Knowledge, and it is multi-generational, being passed on and adapted to changing circumstances.

Today we have much to learn from the Traditional Ecological Knowledge of the Indigenous peoples of the world. It is in many ways crucial to humanity's survival and well-being.

For students, learning lessons from the Traditional Ecological Knowledge of Indigenous peoples can have a significant impact on the growth of their personal Ecological Knowledge. This unit, as well as other units in this guide, encourages students to learn from the knowledge and understandings of First Peoples to develop their own positive connections with the land and the environment.

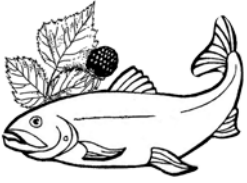

## UNIT 1 • TRADITIONAL ECOLOGICAL KNOWLEDGE

### First Peoples' Connections

Since Time Immemorial, First Peoples have prospered and continue to exist alongside nature in this world. Their lifestyle before contact did not challenge the carrying capacity of the land. The land provided food, medicines, tools, clothing, and shelter: everything. Traditional cultural knowledge provides an ability to utilize animal parts, stones and natural materials to construct complex tools, survive in extreme conditions, travel long distances, and make medicines. This knowledge is vast and all encompassing; to understand one's surroundings was, and is, paramount and transmitted with respect through the oral tradition of storytelling, dance, language and personal experience. It continues to be shared through intergenerational teachings today.

Some key features of Traditional Ecological Knowledge include the following:

- It is a system of knowledge
- It is specialized knowledge of the interconnectedness of all aspects of the world
- It connects with worldview, values and beliefs shared by a group of First Peoples
- It is local place-based knowledge about ecosystems in a particular territory
- It is cumulative, having been learned and passed on over a long period of time
- It enables a sustainable use of resources
- It holds knowledge about how to survive in a specific territory from one generation to the next
- It enables people to be adaptable, dynamic and resilient in the face of change

#### *MAIN AREAS OF TRADITIONAL ECOLOGICAL KNOWLEDGE*

- Worldview and belief systems
- Practical knowledge and skills
  - biology of species of plants and animals
  - understanding of life cycles
  - if species are edible or poisonous
  - harvesting and processing skills
  - using natural resources to make tools and other material goods
  - knowledge about how species change in an ecosystem after a disturbance (ecological succession)
- Learning and teaching of skills and knowledge from one generation to the next
  - language
  - stories
  - ceremonies
  - demonstration
  - participation

Adapted from Nancy J. Turner, *Ancient Pathways, Ancestral Knowledge*, v 1 pp 35-37.



## PLANNING TO TEACH THE UNIT

This unit is intended to provide an introduction to the topic of Traditional Ecological Knowledge. It can be adapted for all grade levels, and provides opportunities for cross-curricular studies.

### *OUTLINE OF ACTIVITIES*

1. Traditional Territories
2. Time Immemorial
3. Sense of Place Through Traditional Stories
4. What is Traditional Ecological Knowledge (TEK)?
5. Clam Gardens: A TEK Example
6. Plant Resource Manage: A TEK Example
7. Tanning Hides
8. Understanding Nature's Signals
9. Exploring Traditional Ecological Knowledge

### **Enduring Understandings**

Traditional Ecological Knowledge is essential for First Peoples' survival over countless generations.

Traditional Ecological Knowledge is crucial for human survival and well-being.

### **Essential Questions**

How have First Peoples demonstrated sustainable environmental practices since time immemorial?

What can we learn from the Traditional Ecological Knowledge of Indigenous People?



BC Curriculum Connections	
<b>Suggested Topics and Inquiry Questions</b>	<b>Learning Standards</b> Selected Curricular Competencies and suggested Content Standards. Other Learning Standards may also be applicable.
<b>Science 5</b>	
TEK shows First Peoples’ understandings of structures and functions of the animals in their territories <ul style="list-style-type: none"> <li>• How does Traditional Knowledge about body systems help First Peoples prepare and store food for the winter?</li> </ul>	<i>Curricular Competencies</i> Identify First Peoples’ perspectives and knowledge as sources of information  Express and reflect on personal, shared, or others’ experiences of place
	<i>Content</i> Basic structures and functions of body systems: digestive, musculo-skeletal, respiratory, circulatory
Interconnectedness of First Peoples and their territories <ul style="list-style-type: none"> <li>• How can you show ways that local First Peoples are connected in many ways to their environment?</li> <li>• How do First Peoples traditionally pay respect to the environment where they live?</li> </ul>	<i>Curricular Competencies</i> Experience and interpret the local environment  Express and reflect on personal, shared, or others’ experiences of place
	<i>Content</i> First Peoples’ concepts of interconnectedness in the environment
First Peoples’ knowledge of sustainable practices <ul style="list-style-type: none"> <li>• How can we apply First Peoples’ understandings of sustainable use of the land and resources?</li> </ul>	<i>Curricular Competencies</i> Identify some of the social, ethical, and environmental implications of the findings from their own and others’ investigations
	<i>Content</i> First Peoples’ knowledge of sustainable practices





Science 6	
<p>TEK shows First Peoples’ understandings of structures and functions of the animals in their territories</p> <ul style="list-style-type: none"> <li>• How does Traditional Knowledge about life cycles help First Peoples harvest food in their territories?</li> </ul>	<p><i>Curricular Competencies</i> Choose appropriate data to collect to answer their questions</p> <p>Identify First Peoples perspectives and knowledge as sources of information</p>
	<p><i>Content</i> The basic structure and functions of body systems – excretory, reproductive, hormonal, nervous</p>
<p>Historical and current First Peoples’ use of force and power in a variety of technologies</p> <ul style="list-style-type: none"> <li>• How do First Peoples use their understanding of force, power and gravity to carry out activities such as build houses, raise totem poles and hunt large animals?</li> </ul>	<p><i>Curricular Competencies</i> Identify questions to answer or problems to solve through scientific inquiry</p> <p>Transfer and apply learning to new situations</p>
	<p><i>Content</i> Effects of balanced and unbalanced forces in daily physical activities</p> <p>Force of gravity</p>
Science 7	
<p>First Peoples Traditional Knowledge about survival needs of organisms</p> <ul style="list-style-type: none"> <li>• How did/do First Peoples use their knowledge of organisms’ survival needs to modify the environment for harvesting? (eg clam gardens, controlled burning, herring roe harvesting )</li> </ul>	<p><i>Curricular Competencies</i> Use scientific understandings to identify relationships and draw conclusions</p> <p>Express and reflect on a variety of experiences and perspectives of place</p>
	<p><i>Content</i> Survival needs – all organisms need space, food, water and access to resources in order to survive</p>
<p>Local First Peoples traditional knowledge of changes in biodiversity</p> <ul style="list-style-type: none"> <li>• How has First Peoples’ traditional knowledge about changes in the populations of plants and animals helped scientists with their studies?</li> </ul>	<p><i>Curricular Competencies</i> Make observations aimed at identifying their own questions about the natural world</p> <p>Apply First Peoples perspectives and knowledge, other ways of knowing, and local knowledge as sources of information</p>
	<p><i>Content</i> First Peoples knowledge of changes in biodiversity over time</p>



UNIT 1 • TRADITIONAL ECOLOGICAL KNOWLEDGE

Science 8	
First Peoples’ understanding of the characteristics of life in plants and animals <ul style="list-style-type: none"> <li>• How do First Peoples’ understandings of the characteristics of life affect the ways they traditionally use the resources of their territories?</li> </ul>	<i>Curricular Competencies</i> Formulate alternative “If...then...” hypotheses based on their questions  Use scientific understandings to identify relationships and draw conclusions  Transfer and apply learning to new situations
	<i>Content</i> Characteristics of life – living things respire, grow, take in nutrients, produce waste, respond to stimuli, reproduce
First Peoples traditional knowledge of local geological formations <ul style="list-style-type: none"> <li>• How do First Peoples apply knowledge about local geological formations to the traditional use of their territories</li> </ul>	<i>Curricular Competencies</i> Experience and interpret the local environment
	<i>Content</i> First Peoples’ knowledge of local geological formations
Science 9	
Interconnectedness is a key concept of Traditional Ecological Knowledge <ul style="list-style-type: none"> <li>• How can we apply First Peoples perspectives on interconnectedness for a sustainable future?</li> </ul>	<i>Curricular Competencies</i> Apply First Peoples perspectives and knowledge, other ways of knowing, and local knowledge as sources of information
	<i>Content</i> First Peoples perspectives on interconnectedness First Peoples perspectives on sustainability of systems

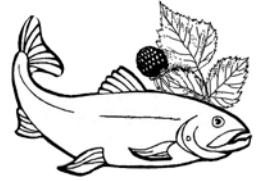

## Cross-Curricular Links

### *SOCIAL STUDIES*

Learning about Traditional Ecological Knowledge can be correlated with Social Studies courses. Below are some possible areas of implementation of the BC Learning Standards.

SS 5:

- First Peoples land ownership and use

SS 6:

- Economic policies and resource management, including effects on Indigenous peoples

SS 7:

- Human responses to particular geographic challenges and opportunities, including climates, landforms, and natural resources

SS 8:

- Scientific and technological innovations

### *ENGLISH LANGUAGE ARTS*

Traditional narratives and texts that embed Traditional Ecological Knowledge can be used in parallel with its study in Science class, meeting the relevant First Peoples-related Curricular Competencies. For example:

ELA 5:

- Demonstrate awareness of the oral tradition in First Peoples' cultures and the purposes of First Peoples' texts
- Identify how story in First Peoples' cultures connects people to land

ELA 6, 7, 8, 9:

- Recognize and appreciate the role of story, narrative, and oral tradition in expressing First Peoples' perspectives, values, beliefs, and points of view

ELA 7:

- Recognize the validity of First Peoples' oral tradition for a range of purposes

ELA 8:

- Develop an awareness of the protocols and ownership associated with First Peoples' texts

ELA 9:

- Develop an awareness of the diversity within and across First Peoples' societies represented in texts

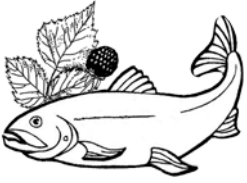

## UNIT 1 • TRADITIONAL ECOLOGICAL KNOWLEDGE

### Suggested Resources

- Map of the First Peoples of BC, <http://ow.ly/gxQ7303qu3U>
- Blackline Master 1-1, What is Traditional Ecological Knowledge? page 44
- Blackline Master 1-2, Clam Gardens, page 45
- Blackline Master 1-3, Plant Resource Management, page 47
- Blackline Master 1-4, Reading Nature's Signals, page 49
- Blackline Master 1-5, Research Using the 7Es, page 50
- Blackline Master 1-6, Traditional Ecological Knowledge Research, page 51

### Suggested Activities

#### 1. TRADITIONAL TERRITORIES

Discuss the traditional territories that your school or community sits on. Your discussion will depend on your location; if you are in or near a First Nations community the answer may be clearer than in an urban setting.

a. Ask students to suggest what “traditional territories” means to them. Share ideas and come up with a consensus on what it means.

b. Note that “traditional territories” may be interpreted at different levels:

- The traditional territories of a First Peoples or language group, such as Tahltan, Dakelh or Nuxalk. For younger students this may be the most useful level of interpretation. For a map of the First Peoples of BC, go to <http://ow.ly/gxQ7303qu3U>.
- The traditional territories of a local First Nation, band or community, such as Kwadacha, Tkemlúps, or Tsawwassen First Nations.
- The traditional territories of a family or clan group within these broader groups.
- Traditional territories referred to in this context may not be the same as those lands under legal or political considerations such as land claims. Boundaries between territories are not precise.

c. Map some important locations within the traditional territories, using the First Nations names. Emphasize the importance of using the traditional names of territories. Map places such as lakes and rivers, communities within the territories, and significant cultural locations. There may be maps and other resources available from the local First Nations community. Another resource is *A Traveller's Guide to Aboriginal B.C.* by Cheryl Coull.

- Learn to pronounce some of the important place names, if the students are not familiar with them. Work with a language teacher or other community member to learn the correct pronunciation.
- A search on the internet might also help students find websites that help with the pronunciation of words in some First Nations languages.

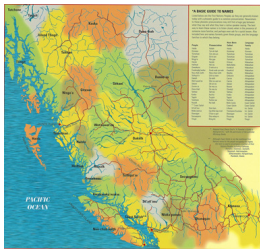

First Peoples of  
BC map



## 2. TIME IMMEMORIAL

One definition of traditional territory is “the area that the local Indigenous people have occupied since Time Immemorial.” Introduce students to the term *time immemorial*: since creation; before recorded history.

- “Time immemorial” expresses the depth of time that Indigenous people have lived sustainably on their territories. It is time beyond memory.
- a. Discuss with students their earliest memories. What types of topics or activities make up their early memories?
    - Talk about what they know about their families before they were born.
    - Ask how they came to know about their family history. (e.g. family stories, photo albums, home videos, books).
    - How far back in time do our family stories go?
  - b. Discuss how time is experienced by most of us today. Many people tend to live in a world of immediate gratification. When we want something: we usually have it within a short period of time. We consume, we discard, often without a thought of the effect on the environment.
    - Ask to students to compare the modern experience of time with that of First Peoples who flourished for thousands of years in harmony, and with respect for the environment.
    - Discuss “How did First Nations survive in their territories from one generation to the next?”
  - c. View a video that presents the idea of interconnectedness and respect for all things.
    - Secwepemc World View, a one minute video found on Youtube at <http://ow.ly/2ZIC303qurx>.
    - Mary Jack, First Nations Elder, speaker and story teller of the Tseycum First Nation. View several short clips of Mary Jack on Youtube. Suggested clips are: 1, Introduction and permission; 10, food: respect for what creator made; 11, Healing all around us; 15, Teaching of respect; 16, Wonderful food from nature. Find online at <http://ow.ly/myqO303quTG> or search for “Mary Jack conversationworks”

## 3. SENSE OF PLACE THROUGH TRADITIONAL STORIES

A sense of place is often embedded within traditional narratives and stories. In this activity, give students an opportunity to find evidence of ways that stories convey a sense of place.

- a. If possible, arrange for a local First Nations storyteller to visit the class. Ensure that they understand the purpose of the lesson so they can prepare a story that exemplifies the local sense of place.
  - See suggestions for inviting speakers into the class, page 14.

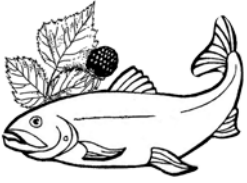

## UNIT 1 • TRADITIONAL ECOLOGICAL KNOWLEDGE

- You may also want to have the speaker discuss Traditional Ecological Knowledge at this time if appropriate. (See Activity 9.)
- b. Discussions of sense of place run throughout the book *River of Salmon Peoples*. Some examples are:
- p. 54-55, Secwepemc, Sense of place and Coyote stories
  - p. 84-87, Secwepemc, the salmon creation story
  - p. 147-148, The Legend of Shushwap Falls
- c. When students read or listen to stories, ask them to locate indicators that reveal the territory of the people who told the story. Clues may be found in the type of animals and plants mentioned in the story, or physical features such as bodies of water or mountains. Other indicators may be weather or seasonal duration.
- Students may notice that there are lessons, values and types of stories that have similarities; however there are explicit characteristics within the story that localize it, making it significant to the territory it belongs.
  - Have students share their findings in a class discussion or journal entry. Use their responses as formative assessment opportunity to enhance their understanding of “sense of place.”
- d. The types of narratives the students investigate will depend on your location and the age of the students. Some suggestions for resources include:
- The Story of the Grasshopper in *Coyote and the Sun and Other Stories*. This short narrative could be read aloud as an introductory example.
  - Gather published materials from your school or public library. Ensure they are authentic stories. See some suggested books listed in Additional Resources below.
  - Listen to stories being told. You may have recorded versions of elders telling local stories, or other audio resources to access. You may want to use selections from the following hour long radio presentations found online:  
Secwepemc: <http://ow.ly/qiUO303qv34>  
Haida: <http://ow.ly/cEvE303qv4P>  
Kwakwaka'wakw: <http://ow.ly/jk3i303qv6a>
  - Sto:lo story of Hatzic Rock, found at the Simon Fraser University Museum of Archeology and Ethnology site, [www.sfu.museum](http://www.sfu.museum). Direct link at: <http://ow.ly/PT8U303qvgh>. Transcript at <http://ow.ly/Eqlj303qvhK>.



#### 4. WHAT IS TRADITIONAL ECOLOGICAL KNOWLEDGE?

Traditional Ecological Knowledge is simply stated, but it encompasses many different strands. These activities will help to establish a basic understanding of the concept.

- a. Begin with asking the students the question, “What does a person need to know to survive in the modern world?”
  - Leave the question open to interpretation, and have students work in groups to answer it, then share with the whole class.
  - You may want to have students classify their responses, such as knowledge to provide basic needs, to work, to use technology, or to raise a family.
- b. Discuss the question “How would you survive if the power suddenly went off for good?”
- c. Refer back to the question asked in Activity 2: How did First Nations survive in their territories from one generation to the next?
  - Ask students to brainstorm what types of things the people living on the local lands would have needed to know to survive since Time Immemorial.
  - Develop a list of types of knowledge and wisdom people would need to know.
- d. Discuss with students why living sustainably on the land was essential to their survival. Guide students to think about how First Peoples interacted with the plants and animals that live on the land, and to consider the importance of making sure the resources of the land were not depleted.
- e. If it hasn’t come up yet, introduce the term Traditional Ecological Knowledge. Depending on the age of your students you can explain the meaning or elicit ideas of what it might involve.
  - As a starting point, you may want to use Blackline Master 1-1, What is Traditional Ecological Knowledge. Students could elaborate on each of the main points, working in pairs or groups.
- f. Refer students back to the stories they studied in Activity 3. Ask them to recall examples of Traditional Ecological Knowledge in the stories they read.
  - Did students observe TEK practices in the story they studied?
  - Did students find any indicators of specialized uses of natural resources?
  - Did they find examples of interconnectedness in the ecosystem described in the story.



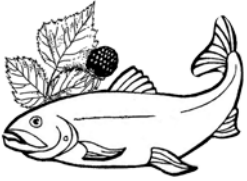

## UNIT 1 • TRADITIONAL ECOLOGICAL KNOWLEDGE

### 5. CLAM GARDENS: A TEK EXAMPLE

In order for students to understand the concepts of Traditional Ecological Knowledge Systems, you may want to illustrate TEK through a study of the Clam Garden, one of many resource management methods used by coastal First Nations.

- a. Ask students to read the article “Clam Gardens,” on Blackline Master 1-2 to find examples of Traditional Ecological Knowledge.
- b. View the video *Mysteries of Ancient Clam Gardens*. This can be found on Youtube at <http://ow.ly/Gdme303qvr1> or search for the title.
  - For a short view of a clam garden through the changing tides, view the time lapse video found on Youtube at <http://ow.ly/gvto303qvyC>.
- c. As a formative assessment activity, students could illustrate a clam garden, or build a model or diorama of a beach with a clam garden. They should label or be able to explain orally ways that the clam garden illustrates TEK.
- d. Clam gardens can serve as a good topic to compare Indigenous Knowledge and Western Science. It is only very recently (since around 2006) that clam gardens were widely noticed or understood by the scientific world or general public.
  - Students might consider why such a significant resource management technology was virtually unknown by science for so long. Some resources include:
    - *Clam Gardens*, by Judith Williams.
    - The Clam Garden Network. Website available at [clamgarden.com](http://clamgarden.com)
    - A report on a scientific study is available online: *Ancient Clam Gardens Increased Shellfish Production: Adaptive Strategies from the Past Can Inform Food Security Today*. Search the keywords “Ancient Clam Gardens PLOS” or link directly at <http://ow.ly/NJ1L303qvDU>.

### 6. PLANT RESOURCE MANAGEMENT: A TEK EXAMPLE

Another example of Traditional Ecological Knowledge is found in the ways that First Nations throughout British Columbia practiced plant management.

- a. Using the text on Blackline Master 1-3, Plant Resource Management, ask students to read about ways that First Peoples enhanced the production of plants they harvested.
- b. Have students research one of the plant management methods. They could work in groups, and create a poster for one of the methods. The posters for all the techniques could be displayed together.
- c. Discuss how these management techniques demonstrate TEK. Refer back to Blackline Master 1-1.





### 7. TANNING HIDES

Students can investigate the Traditional Knowledge involved in tanning moose, deer and caribou hides, especially if there are knowledgeable people in your community who continue this tradition.

- a. Where possible make connections local First Nations who continue to tan hides. You may be able to visit them when they are tanning, or you may invite them to the classroom.
- b. The Secwepemc Connecting Traditions website (<http://secwepemc.sd73.bc.ca>) gives details about tanning hides. Students can study it to find examples of traditional knowledge.
  - Go to this link – <http://ow.ly/RzJw303qDAR> – and select Tanning Hides link from menu on the right.
  - View a short video that shows an Elder teaching University of Northern BC students how to tan hides. <http://ow.ly/Bc4l303qDLv>.
  - Ask students to find some scientific principles involved in tanning hides, such as chemical reactions and physical changes.

### 8. UNDERSTANDING NATURE’S SIGNALS

An important part of a Traditional Ecological Knowledge system is the knowledge about the timing of events in the life cycles of plants and animals.

Background Notes: Certain species act as signals for other life cycle events or natural phenomenon. (Scientists call them phenological indicators, and this key knowledge is called “traditional phenological knowledge.”)

- Part of TEK involves observing the signals and relating it to food harvesting. For example, some people watch for a bird known as the salmonberry bird. When they hear it singing, they know it is time to pick salmonberries. People also know that when salmonberries ripen it is the signal that sockeye salmon are returning to the local rivers.
  - Signals can also be read in the sky, such as the phases of the moon, the appearances of stars and the position of the sun.
  - Other signals can be read by those who have the knowledge to predict changes in the weather, or the abundance of a certain species in the coming seasons.
- a. Calendars: In many traditional calendars of BC First Nations, some of the months or seasons are named for significant plants or animals.
    - Ask students to study the local Indigenous calendar, if available, for TEK embedded in the names of the months.
  - b. Use Blackline Master 1-4 as a model for students to research local knowledge about nature’s signals.
    - Depending on your location, students may be able to ask Elders or family members.



## UNIT 1 • TRADITIONAL ECOLOGICAL KNOWLEDGE

- If local experts are not available, students may access printed material, such as:
  - the interviews found in the unit *Traditional Ecological Knowledge and Climate Change* found online at [www.ecoknow.ca/curriculum.html](http://www.ecoknow.ca/curriculum.html).
  - If it is available, students can refer to *Ancient Pathways, Ancestral Knowledge*, volume 2, pages 18-20 for a table of examples.

### 9. EXPLORING TRADITIONAL ECOLOGICAL KNOWLEDGE

Invite students to research an example of Traditional Ecological Knowledge held by First Nations in the local region.

- a. Invite an Elder or knowledge keeper into the class to speak about some aspects of Traditional Ecological Knowledge that they are familiar with in the local area. See suggestions for inviting a speaker into the classroom, page 14.
  - Prepare students for the visit by asking them to generate questions to ask the speaker.
- b. Have students brainstorm types of TEK they might research.
  - Discuss what important plants, animals and materials people used in the past and continue to use. What was important to know about them so that people could use them sustainably?
  - Discuss some of the skills and processes that people needed to know about to use the natural resources.
  - Suggest possible areas of study such as food, shelter, clothing, tools, medicine.
- c. Ask students to create a question about a specific area of traditional knowledge that they would like to explore.
  - As students formulate their questions, informally assess their ability to meet the Curricular Competency: *Explore and pose questions that lead to investigations*.
- d. Have students conduct the research into their question.
  - Decide how students will conduct their research. You may want them to work individually, or have them work in groups if they have similar topics.
  - Provide opportunities for students to find and consult reference materials, including library books and online sources.
  - Where possible, encourage students to use real life sources, such as
    - interviewing Elders or family members
    - taking pictures or video of the relevant plant, animal or habitat
    - visiting a harvesting or processing site
  - You may want to use Blackline Masters 1-5, Researching with the 7Es or Blackline Master 1-6, Traditional Ecological Knowledge Research to help guide students in their research.



- e. Have students prepare and present their research in an interesting format. This may be a poster, booklet, video, report, display, or digital presentation.
- Encourage students to include samples, photos, illustrations or models in their project.
  - Ensure students include relevant vocabulary from the language of the local First Nations, and make reference to traditional territories involved.
  - Have students or groups present their final projects. You may want to make it a community event, or invite Elders in to participate.

## Assessment

Here are some suggestions for assessing the Essential Questions of the unit. See general suggestions for assessment in the Introduction, page 24.

1. How have First Peoples demonstrated sustainable environmental practices since time immemorial?
  - a. Ask students to create a Mind Map focussing on the phrase “Sustainability and TEK.” How do traditional harvesting practices demonstrate sustainability in First Peoples’ use of the natural environment?
  - b. Informal question: During discussion of one of the topics, ask students to explain how a certain aspect of Traditional Ecological Knowledge was important for the survival of a community.
  - c. Students can create a project that demonstrates one example of sustainable practices. It could be in the form of a report, a model or digital presentation.
  - d. Students can write a letter to the government or an environmental agency that suggests ways that traditional practices could be used today.
2. What can we learn from the Traditional Ecological Knowledge of Indigenous People?
  - a. Ask students to complete a K-W-L (Know-Wonder-Learn) as they progress through the unit. Consider the question *What can the world learn from the Traditional Ecological Knowledge of Indigenous People?*
  - b. Ask students to record journal entries as they progress through the unit that make connections with Traditional Ecological Knowledge and environmental practices (or lack of them) today.
  - c. As students work on the activities, particularly the research activity (Activity 9), use informal questioning at appropriate moments to get students to think about how TEK could be applied today.
  - d. Keep a chart on the wall and encourage students to add ideas through the course of the unit that suggest how and what we can learn from TEK.

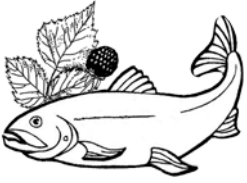

## UNIT 1 • TRADITIONAL ECOLOGICAL KNOWLEDGE

### Additional Resources

Aboriginal Education, Kamloops School District. *Science Resources*.

Elementary: <http://sd73aboriginaleducation.weebly.com/science.html>

Secondary: <http://sd73aboriginaleducation.weebly.com/science1.html>

These two lists provide many useful resources for the Secwepemc and many other First Nations.

*Connecting Traditions*. Secwepemc Nation. <http://secwepemc.sd73.bc.ca/>

This interactive multimedia presentation gives cultural information about the Secwepemc people.

Coull, Cheryl. *A Traveller's Guide to Aboriginal B.C.* Whitecap Books, 1996.

An overview of all First Nations communities in BC, with local information, including tribal and community names, and significant cultural features.

*Coyote and the Sun and Other Stories*. Secwepemc Cultural Education Society, Kamloops BC. 1993.

*First Voices*. <http://www.firstvoices.com>

Online dictionaries with pronunciations for many BC First Nations languages.

*First Peoples of BC Map*. BC Ministry of Education.

[www.bced.gov.bc.ca/abed/images/map2.jpg](http://www.bced.gov.bc.ca/abed/images/map2.jpg)

Ignas, Veronica. *Two Ways of Knowing, Traditional Ecological Knowledge Meets Western Science*. 2003. <http://www.ecoknow.ca/curriculum.html>

Students compare Traditional Ecological Knowledge and Scientific Knowledge using case studies of Indigenous Plant Classification, the Pine Mushroom Industry in North West British Columbia, the Smallpox Epidemic of 1862 and the impact of AIDS today.

*A Journey Into Time Immemorial*. Simon Fraser Museum of Archaeology and Ethnology, 2008. [www.sfu.museum/time/](http://www.sfu.museum/time/)

This multimedia site explores the traditional lives of the Stó:lō people.

McLeod, Elaine, and Colleen Wood. *Lessons from Mother Earth*. Toronto: Douglas & McIntyre. 2002.

MacPherson, Nancy Elizabeth. *Traditional Knowledge for Health (Nlaka'pamux)* Masters thesis, UBC, 2009. <http://bit.ly/2dBfaM8>

This thesis studies the TEK of the Nlaka'pamux Nation as it relates to health.

*People of the Land : Legends of the Four Host First Nations*. Theytus Books. 2009.

Narratives of the Lil'wat, Musqueam, Squamish and Tsleil-Waututh First Nations published in connection with the 2012 Vancouver-Whistler Olympics.

*River of Salmon Peoples*. Theytus Books, 2015.



Memories, stories and voices of First Peoples living in the Fraser River watershed, including Musqueam, Lil'wat7ul Mount Currie, Secwepemc, Nle'kepmxcinm, Dakelh & Tsilhqot'in, Sardis Stó:Lō and Seabird Island Stó:Lō.

Sellars, Willie, and Kevin Easthope. *Dipnetting with Dad*.

A boy learns much about his Secwepemc culture through activities with his father, focusing on the dipnetting for salmon. Themes include family values, storytelling, traditional ecological knowledge and coming of age. The author is a member of the Williams Lake Indian Band.

Thompson, Judy. *Traditional Plant Knowledge of the Tsimshian*. 2003.

<http://www.ecoknow.ca/curriculum.html>

Students apply understandings of Traditional Ecological Knowledge to plant identification, classification, traditional cultural practices and nutrition.

Turner, Nancy J. *Ancient Pathways, Ancestral Knowledge*. Volumes 1 and 2. McGill-Queen's University Press, 2014.

An extensive study of how knowledge of plants and environments has been applied and shared over centuries and millennia by Indigenous peoples.

Turner, Nancy J. "Not One Single Berry": Indigenous Knowledge and Environmental Change in British Columbia.

<http://www.firstnations.de/media/06-4-1-turner.pdf>.

This article details how BC First Peoples traditional knowledge informs us about environmental change.

Turner, Nancy J., Marianne Boelscher Ignace, and Ronald Ignace. "Traditional Ecological Knowledge And Wisdom Of Aboriginal Peoples In British Columbia." *Ecological Applications* 10.5 (2000): 1275-287. Available online at [https://www.fws.gov/nativeamerican/pdf/tek\\_turner-2000.pdf](https://www.fws.gov/nativeamerican/pdf/tek_turner-2000.pdf) or search for title.

Williams, Judith. *Clam Gardens*. New Star Books, Vancouver. 2006.

One of the first studies to examine the management of clam beds by coastal First Nations.

Wright, John and Duane Johnson. *Indigenous Knowledge and Cultural Weather Perspectives: Lessons to Support Science 10*. Saskatchewan Teachers Federation. 2007. Online. (Search on title keywords.)

These lessons examine cultural perspectives on weather and weather predictions. Based on Saskatchewan First Peoples, but may be adapted for BC.

## **What is Traditional Ecological Knowledge?**

TEK is Local Knowledge

TEK is Cumulative Knowledge

TEK understands Interconnectedness

TEK is necessary for Survival

TEK practices Sustainability

Traditional Ecological Knowledge understand the connections between aspects of the local ecosystem:

- Plants species
- Animals species
- Habitats
- Landforms
- Weather
- Seasonal changes



## Clam Gardens

One of the food sources that helped coastal First Nations survive in the past was the clam. If you go to an ancient village site along the British Columbia coast, you will find it is built on deep layers of white shells from clams and other shellfish, like cockles and mussels.

Clams are very nutritious. They are rich in protein, and also nutrients such as iron, Vitamin C and Vitamin D.

There are four main species of clams along the BC coast: butter clam, littleneck, horse clam, and cockles.

### Harvesting clams

Clams and cockles are easy to harvest by all members of the family. They live below the surface of beaches in the intertidal zone. They sometimes give themselves away by squirting water through holes.

In the past, clams and cockles were a dependable food source. People could almost always find a good feed of shellfish, summer or winter.

The best time of year to gather clams is in the winter. In warmer months people knew that they might not be safe to eat. They could be polluted by what we call "red tide."

As well as observing the water to see a change in colour, people would watch the animals like seagulls and otters. If they were eating the clams, then people knew they were safe to dig.

### Preserving clams

First Nations families harvested large amounts of clams in the past. Some were eaten fresh, but most were preserved to be eaten later.

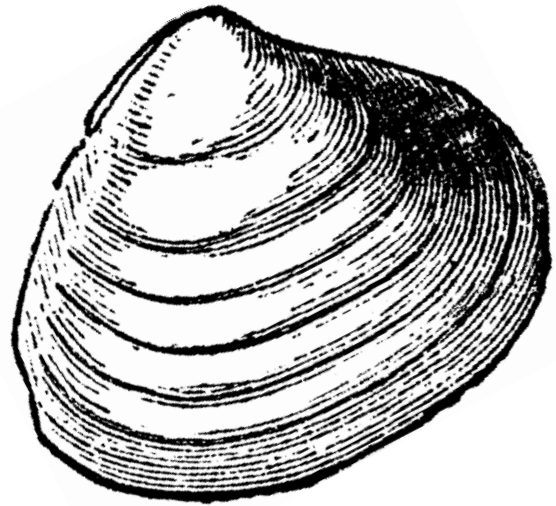

The shellfish were steamed open and the meat was threaded onto sticks to be roasted or smoked over a fire. Some people put them between mats and stomped on them to make them more tender.

The dried clams could be stored for a long time, or they could be traded with other First Nations.

The clams made a good snack. Sometimes people strung them on strings which they wore around their neck. If they got hungry while going about their work, they could pull off a clam to eat.

### Clam gardens

We know clams were an important food source in the past because First Peoples built large clam gardens to improve the quality and quantity of the clams.

To do this, people long ago built walls along a sloping beach, and filled it in with sand to make level ground.

All along the Pacific coast, First Nations people built thousands of these beach terraces. In one bay alone on Quadra Island there are at least 49 separate gardens.

It took a great deal of knowledge to build and maintain these gardens. First, the builders had to understand the currents and tides to know the best places to build them.

The clam gardeners must have had a detailed understanding of the intertidal ecosystem to create such successful technology to manage their shellfish harvest.

The walls were as much as two meters high. They were created by rolling boulders down to the lowest of the low tide levels.

The rock walls were built at just the right height so the sandy terrace behind it would create the best growing habitat for the clams.

They waves washing over it would bring in nutrients. As people harvested the clams and cockles, using their digging sticks, they kept the sand loose enough for the shellfish to move about.

Certain people in the community were stewards of the clam gardens. They would observe the condition of the gardens. They would make sure there was no overharvesting. If the quality or number of clams got too low, they would leave the

area untouched for a period of time.

Sometimes they would take small clams from another clam beach and “plant” them on a struggling beach.

Scientists have done some tests in clam gardens and found that more clams grow on beaches with walls than regular beaches. As well, clams grow faster and are more likely to survive in clam gardens.

The vast system of clams gardens wasn’t built quickly. They were built over many generations. Families passed on the knowledge and skills involved so that the gardens could be continue to be cared for.

The use of the clam gardens was part of First Nations political and social organization. In some communities certain families or hereditary groups had the use of certain gardens, which were passed down. As well as the rights to use the gardens went the responsibility to care for them.

### **Sea Garden**

The rock walls did more than hold back the sand for the clam gardens. They also created a reef ecosystem where other sea creatures could live, such as octopus, sea cucumbers and chitons. These are all seafood delicacies, and no doubt were an added benefit to the clam gardeners.



## Plant Resource Management

Indigenous people have lived in harmony with the environment for thousands of years. The environment has sustained them. Methods of respectful harvest of these plants and animals were a way of life for thousands of years and reflect Traditional Ecological practices since time immemorial.

Over time, traditional names have reflected the use and the season of the plant. The numerous names for berries, for example provide a vast explanation for the people. A full understanding of one's environment was essential, seasons, weather and moons dictated travel, harvest and ceremonial events.

Indigenous people are known to travel great distances traversing long distances over mountains and valleys gathering food. Ecological indicators revealed when it was time to move on into neighbouring areas, and which areas to move onto next.

Harvesting techniques reflect an immense respect and reciprocity. Thanks were given to the Creator both before and after taking anything from Mother Earth. Spirituality was a key to the sustenance way of life and this unique relationship with the land.

When things were taken, nothing was wasted and all was shared. All plant parts were used following the harvest, as were all the animal parts following a hunt.

First Peoples' survival depended on using the resources in what we would call today a sustainable manner.

Here are a variety of harvesting techniques practiced by First Peoples throughout the province.

### Soil Aeration

During the harvest of some plants, the soil was aerated as people used root digging sticks during the harvest. Children would help. This process was gentle and would serve to aerate the soil without damaging it.

### Crop Rotation

Today we call it crop rotation. In the past each site would be rested for a necessary period of time before revisiting.

People would never harvest the same area intensively year after year. They would go back only once the area was renewed and ready for harvest. That is why it could take such a massive area to sustain a large group of people

### Selective Harvesting

People would never harvest all of the plants from one area simply because they needed the food. They would harvest discriminatingly, putting back the immature or smaller bulbs or roots to produce in following years

### Replanting

Replanting of smaller roots as well as seeds would occur which would promise a future crop in years ahead.

### **Pruning**

Branches could be broken off and brought back to harvest berries off some berry plants. This would produce natural pruning without harming the bush. Some berry bushes were cut right back to the ground since the new suckers were the ones to produce the berries.

### **Women as Managers**

Women possessed vast amounts of knowledge and passed this on to children. They were recognized as very important figures in holding and passing on the knowledge.

### **Landscape Burning**

Controlled burning of an area was an important way of managing and improving some traditional territories. People understood that the soil needed to be renewed. Burning accomplished this.

Burning had other purposes. It could clear land for important plants to grow, such as berries, camas, grasses, and medicinal plants.

Sometimes it was used to fireproof areas around certain medicinal plants.

*Baptiste Ritchie, Mount Currie Elder, 1969:*

When there were a lot of bushes then the ripe berries disappear at the roots like potatoes, tiger lily and spring beauty disappear, when it gets too bushy. Then they burned. ... We realize already, it seems the things that were eaten by our forefathers have disappeared from the places where they burned.

*Annie York, Nlaka'pmx Elder, 1991:*

I've seen it, when the old people used to do it. I was just a little girl. I'd go up the mountain with granny. After we'd pick berries, my uncle would say, "It's going to rain pretty soon; time to burn." He stays up after we finished. Then, we go back the next year, it's all burned. Now, it turns into bush. That's why we don't get many berries any more. We're not allowed to burn.

Source: Nancy J. Turner, "Not One Single Berry"

## Understanding Nature's Signals

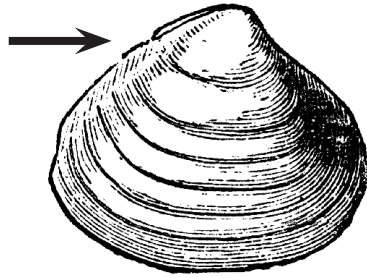

Signal: When the oceanspray plant blooms, the butter clams are ready to harvest.  
Local knowledge of the Comox people.

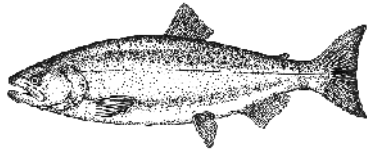

Signal: When the sagebrush buttercup (called spring salmon eye) blooms, it means the first spring salmon are coming up the Fraser River.  
Local knowledge of the Stl'atl'imx people.

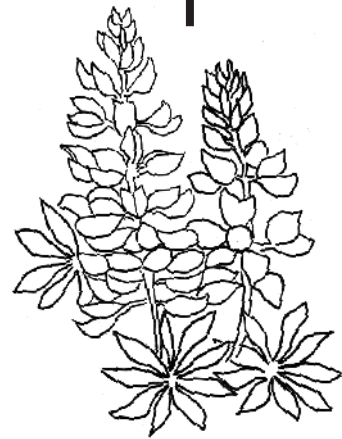

Signal: When the lupine blooms, it is time to hunt marmots.  
Local knowledge of the Okanagan people.

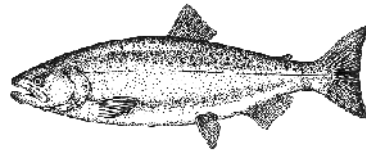

Signal: When the soapberries ripen it means that the sockeye salmon runs are starting.  
Local knowledge of the Secwepemc people.

## Research Using the 7Es

### **Research Question:**

### **Environment**

Have you gone out to the environment, if possible, and explored your question?

### **Engage**

What do you already know? What do you want to know about the question?

### **Explore**

Find out more details about the question.

### **Elder**

Are there traditional stories related to your topic? What words are there in the local First Nations language?

### **Explain**

Record your observations and research findings. Plan how you are going to present the answer to your question.

### **Elaborate**

What other questions come out of your research? Complete your project.

### **Evaluation**

How did you do? Were you satisfied with the answer to your question?

# Traditional Ecological Knowledge Research

Research Question:

Knowledge About Plant, Animal or Material

Harvesting and Processing Skills

Beliefs and Spiritual Connections

Learning and Teaching Knowledge and Skills





## UNIT 2

# PLANTS AND THE CONNECTION TO PLACE

### Introduction

Plants connect us to place. They help establish our communal identity. Most provinces, states and countries have their special trees and flowers. In BC the completion of secondary school is marked by receiving a “Dogwood.” At home people often create gardens, while a requirement for urban planning is an adequate number of parks.

In British Columbia we enjoy a variety of different ecosystems that support a wide diversity of plant species. Each region has its own identity thanks to the particular geography, geology and climate that produce the diversity of habitats.

In this unit students explore the idea of place as it relates to First Peoples’ traditional knowledge about plants.

“Place is any environment, locality, or context with which people interact to learn, create memory, reflect on history connect with culture, and establish identity. The connection between people and place is foundational to First Peoples perspectives of the world.”

(BC Ministry of Education Science Learning Standards 2016)



Pacific flowering dogwood

*t'éqt'eq?ay* (Comox)

*łáw'qamay'* (Squamish)

*qwítx* (flower); *qwítxelp* (tree) (Halkomelem, Upriver)

*t'eq-et'q-áz'* (Stl'atl'imx (Pemberton): )

*Cornus nuttallii* (Latin)





## UNIT 2 • PLANTS AND THE CONNECTION TO PLACE

### First Peoples Connections

Traditional Ecological Knowledge about the diverse plants growing in their territories was crucial for the survival of First Peoples in the past. Today this knowledge is still passed on and is key to the sense of place held by First Peoples. When they go out on the land to pick berries, to dig bitterroot, to gather stinging nettle, bark or grasses, it provides a connection with the land and with their ancestors.

Traditional Knowledge about plants is considered part of First Peoples' intellectual property. While much of this knowledge is shared, remember that some understandings of plants and their uses is protected.

Traditional knowledge of plants is not just about the properties and uses of the plants themselves, but also the specific ecosystems in which they grow. It includes knowledge about harvesting in a sustainable manner, such as selective harvesting and not girdling a tree when removing bark. As well, it includes knowledge about ways to manage the landscape to maintain or improve the products of the plants, such as controlled burning, tilling the soil and transplanting.

As with other resources, traditional knowledge views plants holistically, as a complete living organism interconnected with the rest of the world. There are many dimensions to the wealth of plant resources, such as healing, spirituality, ceremony, nutrition, and technology.

These are acknowledged in the ways that First Peoples show respect when harvesting plants. Often words are spoken or songs sung to a plant to thank it for its sacrifice to nourish or assist them. Some First Peoples may leave a gift as an offering of thanks.

For significant plant species, as with other resources like salmon, some First Peoples hold a special ceremony or event to celebrate the first harvest of the plant. This may be the first berries of the season, or the first digging of root vegetables such as camas or balsamroot.

Central to this unit are the ways in which the interconnections that First Peoples have with the land results in a sustainable use of the resources. Read more about the importance of Place in the Introduction, page 10.

“It is the whole entity of each plant and its essence that is important. In many cases it is truly impossible to separate a plant’s roles into material or spiritual spheres, or into applications of providing nutrition or healing powers, for example; these roles blend together, with no sharp division.”

(Nancy J. Turner, *Plants of Haida Gwaii*, pp 39-40.)



## PLANNING TO TEACH THE UNIT

The topic of traditional knowledge of plant resources provides an excellent opportunity for students to conduct a place-based inquiry sparked by their own curiosity. This unit begins with some suggestions for provoking interest (Activity 1) and for engaging in an inquiry (Activity 2). The following activities explore specific topics that can be incorporated or used on their own.

### Outline of Activities

1. Sharing Plants and Place
2. Plants Used by First Peoples Inquiry
3. Bitterroot: A Plants and Place Example
4. Plants as Indicators
5. Plants in Technology
6. Finding Examples of Traditional Scientific Knowledge
7. Local Plants for Tea
8. Brewing and Blending Tea

### Enduring Understandings

First People's Traditional Knowledge includes a respect for the interconnectedness of humans and plants.

Natural materials have identifiable physical, biological and chemical properties that humans have made use of since ancient times.

Plants contribute to our sense of place and well-being.

### Essential Questions

How can humans interact with plants in a respectful and sustainable manner?

How have First Peoples used their knowledge of plants and their habitats for survival and well-being?

How do First Peoples' perspectives on interconnectedness and place reflect their understandings about plants and their habitats?



Curriculum Connections	
Suggested Topics and Inquiry Questions	Learning Standards
<b>Science 5</b>	
Interconnectedness of humans, plants and the environment <ul style="list-style-type: none"> <li>• How does the understanding that all things are related impact the way that First Peoples traditionally use plants?</li> </ul>	<i>Curricular Competencies</i> Identify First Peoples' perspectives and knowledge as sources of information  Express and reflect on personal, shared, or others' experiences of place
	<i>Content</i> First Peoples' concepts of interconnectedness in the environment
First Peoples' knowledge of sustainable practices <ul style="list-style-type: none"> <li>• What are some examples of ways that First Peoples traditionally make sure plants are used in sustainable ways?</li> <li>• How can we apply First Peoples' understandings of sustainable use of the plants to our care of the environment today?</li> </ul>	<i>Curricular Competencies</i> Choose appropriate data to collect to answer their questions  Identify some of the social, ethical, and environmental implications of the findings from their own and others' investigations
	<i>Content</i> First Peoples' knowledge of sustainable practices
<b>Science 6</b>	
First Peoples' knowledge of extraction methods using plants <ul style="list-style-type: none"> <li>• In what ways is First Peoples' traditional knowledge about mixtures evident in the ways they use plants. (e.g. infusing teas and medicines, whipping soapberries)</li> <li>• How does First Peoples' traditional use of extraction methods demonstrate their knowledge of the properties of certain plants?</li> </ul>	<i>Curricular Competencies</i> Choose appropriate data to collect to answer their questions  Identify First Peoples' perspectives and knowledge as sources of information
	<i>Content</i> Mixtures: local First Peoples' knowledge of separation and extraction methods



<b>Science 6 (continued)</b>	
Plants in the local ecosystems contribute to a sense of place and well-being • How do the plants growing in the local area contribute to First Peoples' sense of place, as well as students' personal sense of place?	<i>Curricular Competencies</i> Express and reflect on personal, shared or others' experiences of place
	<i>Content</i> (no direct link)
<b>Science 7</b>	
Traditional Ecological Knowledge includes the survival needs of plants • What traditional plant management practices demonstrate an understanding of the survival needs of plants?	<i>Curricular Competencies</i> Use scientific understandings to identify relationships and draw conclusions Express and reflect on a variety of experiences and perspectives of place
	<i>Content</i> Survival needs – all organisms need space, food, water and access to resources in order to survive
First Peoples' observation of changes to diversity due to factors such as climate change, industrialization, and urban growth • What can First Peoples' traditional knowledge tell us about how the biodiversity of plants has changed? • How can we apply First Peoples' knowledge to deal with changes in plant biodiversity?	<i>Curricular Competencies</i> Use scientific understandings to identify relationships and draw conclusions
	<i>Content</i> First Peoples' knowledge of changes in biodiversity over time Local First Peoples' knowledge of climate change



UNIT 2 • PLANTS AND THE CONNECTION TO PLACE

Science 8	
First Peoples' knowledge and use of plants <ul style="list-style-type: none"> <li>• In what ways do First Peoples' traditional knowledge about plants and their ecosystems demonstrate an understanding of the characteristics of life?</li> </ul>	<i>Curricular Competencies</i> Use scientific understandings to identify relationships and draw conclusions Transfer and apply learning to new situations
	<i>Content</i> Characteristics of life – living things respire, grow, take in nutrients, produce waste, respond to stimuli, reproduce
Plants in the local ecosystems contribute to a sense of place and well-being <ul style="list-style-type: none"> <li>• How do the plants growing in the local area contribute to First Peoples' sense of place, as well as students' personal sense of place?</li> </ul>	<i>Curricular Competencies</i> Express and reflect on a variety of experiences and perspectives of place
	<i>Content</i> (no direct link)
Science 9	
Interconnectedness of plant ecology with other spheres <ul style="list-style-type: none"> <li>• How do First Peoples' understanding of plants illustrate their knowledge of interconnectedness?</li> <li>• How can we apply First Peoples' perspectives on interconnectedness for a sustainable future?</li> </ul>	<i>Curricular Competencies</i> Apply First Peoples' perspectives and knowledge, other ways of knowing, and local knowledge as sources of information Contribute to finding solutions to problems at a local and/or global level through inquiry
	<i>Content</i> First Peoples' knowledge of interconnectedness and sustainability



## Cross-Curricular Links

### *SOCIAL STUDIES*

SS 5:

- First Peoples land ownership and use

SS 6:

- Economic policies and resource management, including effects on Indigenous peoples

SS 7:

- Human responses to particular geographic challenges and opportunities, including climates, landforms, and natural resources
- Origins, core beliefs, narratives, practices, and influences of religions, including at least one indigenous to the Americas

SS 8:

- Social, political, and economic systems and structures, including those of at least one indigenous civilization

SS 9:

- Physiographic features of Canada and geological processes: Perspectives on the use of natural resources

### *ENGLISH LANGUAGE ARTS*

Traditional narratives and texts that embed knowledge about plants can be used in parallel with Science classes, meeting the relevant First Peoples-related Curricular Competencies. For example:

ELA 5:

- Demonstrate awareness of the oral tradition in First Peoples' cultures and the purposes of First Peoples' texts
- Identify how story in First Peoples' cultures connects people to land

ELA 6, 7, 8, 9:

- Recognize and appreciate the role of story, narrative, and oral tradition in expressing First Peoples' perspectives, values, beliefs, and points of view

ELA 7:

- Recognize the validity of First Peoples' oral tradition for a range of purposes

ELA 8:

- Develop an awareness of the protocols and ownership associated with First Peoples' texts

ELA 9:

- Develop an awareness of the diversity within and across First Peoples' societies represented in texts



## UNIT 2 • PLANTS AND THE CONNECTION TO PLACE

### Suggested Resources

- Local resources with information about traditional plant use
- A display with a collection of pictures, books, and real life objects which illustrate plants and plant technologies used by First Peoples
- *Lessons from Mother Earth* by Elaine McLeod
- The Bitterroot Story, Blackline Master 2-1, page 72
- Traditional Knowledge About Plants, Blackline Master 2-2, page 74
- Wild Tea Fact Sheet, Blackline Master 2-3, page 75
- Blending Teas Workbook, Blackline Master 2-4, page 76
- Tea Testing Lab Report, Blackline Master 2-5, page 77
- Blending Teas Journal Reflection. Blackline Master 2-6, page 78
- Assortment of teas

### Suggested Activities

#### 1. SHARING PLANTS AND PLACE

Introduce the unit with an engaging activity that involves sharing one or more plant resources used by local First Nations. This could be drinking tea made from local plants, eating berries, or perhaps whipping and tasting soapberries.

- a. If possible, involve local First Peoples in the presentation of the tea or other foods. This activity could be used as a provocation and could lead directly into developing an inquiry question. See Activity 2.
  - You may want to invite an Elder or other knowledgeable community members to the class to show how to prepare the tea or foods. At the same time they could discuss the importance of plants to the local First Nations.
  - If it is not possible to have a guest, involve the students in brewing tea made from a locally-available plant. Use a resource such as Hilary Stewart's *Drink in the Wild* to find safe plants from your region.
  - Depending on the time of year and availability, students could go berry picking and share the berries back in the class.
  - If you choose tea making as an activity, a class discussion could talk about how tea connects with culture. Teas are important in many cultures, including First Peoples.
- b. Nature Walk. An alternative, or additional activity, would be to go on a nature walk to explore some of the local plants and their habitats. This could be introductory, or you may want to save this until later in your unit.
  - Ideally an Elder or Knowledge Keeper could guide the class on the walk.
  - Ensure school and community protocols are followed.
  - Students can sketch or photograph different plants that they encounter.





- c. Traditional Plant Knowledge. Ask students to brainstorm different types of knowledge First Peoples had to know in the past, and still know today, to be able to survive by harvesting and using plants from their territories.
- Guide students to consider aspects such as habitat, life cycles, seasons, weather, chemical and physical properties of the plant, sustainable harvesting practices.
  - Students can record their ideas in their journals.
  - Ask students to draw a diagram or illustration that shows the connections between the plant and “the place,” that is the local environment.
- d. Respect for the Land. Use a story that illustrates the need for respect for the environment. It could be a picture book, such as *Lessons from Mother Earth*, or a traditional narrative that demonstrates what happens if people don’t respect nature.
- *Lessons from Mother Earth*. In this picture book, a girl named Tess learns from her grandmother that her “garden” is all of nature that surrounds her. As they pick plants and berries they do so carefully and with respect. Her grandmother teaches her important “rules” about caring for the garden. Tess discovers that if she cares for the Earth, it will provide for her just as it provided for generations past.
    - Ask students to draw a picture of a garden. Share with a partner or group, explaining what are important features of a garden.
    - As a class, discuss what are some of the characteristics of a garden.
    - Read the story to the class. Ask students if the story made them change any of their thoughts about what a garden is.
    - Ask students to recall the rules about the garden that Tess’s grandmother explained to her.
    - Have students create a poster that lists and illustrates the rules. This may be used as a formative assessment activity.
  - Compare this story to others about grandparents and grandchildren learning about the importance of their relationship to the land:
    - *Tea of Life*, a 3-minute video ([www.sacredrelationship.ca/videos](http://www.sacredrelationship.ca/videos)). Dene Artist Roy Salopree discusses a water hole in the muskeg, surrounded by spruce trees. The muskeg water he collects from the hole is made into tea and used as medicine for his family and friends. He is shown on the land with his grandson.
    - *A Walk in the Tundra* by Rebecca Hainnu and Anna Ziegler, an Inuit story.
    - *Relatives with Roots* by Leah Marie Dorion, a Métis story that also comes with a CD to hear the story in Michif.
  - Here are some suggested questions to use in discussing these resources:
    - What do the grandparents in each story teach their grandchildren about collecting plants from the land?
    - What protocols are practiced to show respect for the land and resources?



## UNIT 2 • PLANTS AND THE CONNECTION TO PLACE

- What kinds of traditional plants are collected in each story?
- What are the teachings (or take-away message) in each story?

e. Other Resources. You may find more ideas to incorporate into the study of plants in these resources:

- *Traditional Plant Knowledge of the Tsimshian* by Dr. Judy Thompson. These activities help students apply understandings of Traditional Ecological Knowledge to plant identification, classification, traditional cultural practices and nutrition. Online at <http://www.ecoknow.ca/curriculum.html>
- *First Nations Science & Ethnobotany Unit K-10*. by Donna Walker. 15 activity cards with science and art activities including these plants: salal, miner's lettuce, cow parsnip, salmonberry, sweet camas, red laver, chanterelle mushroom, sphagnum moss, ferns, white fawn lily, lodgepole pine and red cedar, red alder, kinnikinnick, eel grass and oregon grape, cat tails. Lesson topics: Berries (K-7); Characteristics of Plants (K-1); Science Ecology - technology & resource use (8); Life Sciences -fishing technology; Medicinal plants (Sitka spruce, stinging nettles); Plant Identification (ethnobotany field trip); seasons (primary); simple machines and raising a post.
- Secwepemc Cooking. The Connecting Traditions site has a page about plants and cooking. It includes an interactive demonstration of pit cooking. [http://secwepemc.sd73.bc.ca/sec\\_village/sec\\_housefs.html](http://secwepemc.sd73.bc.ca/sec_village/sec_housefs.html)

### 2. PLANTS USED BY FIRST PEOPLES INQUIRY

Invite students to conduct an inquiry into some aspect of First Peoples' traditional use of plants that interests them.

a. Provide students an opportunity to explore possible topics by presenting a variety of resources to inspire their thoughts.

- Set up a centre or display area of pictures, books, and real life objects.
- Create a class list of local plants that are used by First Peoples, or were used in the past.
  - Make a word wall or add a chart with the list to the plants display.
- Ask students to classify the different ways that First Peoples traditionally use plants: for food, for technology, for beverages and for medicines.
- Visit a local museum or nature centre that has information about local First Nations' plant use.
- Invite an artist or craftsperson who uses plant materials to display their work and speak about their craft. (E.g. carver, canoe builder, basket weaver)

b. Spend time discussing with students possible big ideas that could direct their inquiry.

- Use ideas from some of the activities below (Activity 3 to 7) to spark ideas. You could create stations with a short activity for each topic which students can circulate through.



- c. Work with students to generate questions about First Peoples' use of plants.
  - The class can hold a brainstorming session where students suggest a variety of questions. They can be posted on chart paper, or for older students, online at a class forum or wiki, if available.
  - Where appropriate, you can guide students to reformulate some questions. Help to connect student ideas and questions to the curriculum.
  - Ask students, or groups, to formulate an inquiry question that they will explore.
- d. Guide students' exploration of their questions.
  - Discuss different ways they could find answers to their questions, such as story, scientific inquiry, asking local First Peoples, online and print resources.
  - For further suggestions on guiding and assessing inquiry, see Encouraging Inquiry in the Introduction, page 21.
- e. Use the 7 Es model to help organize students inquiries.
  - Adapt the learning processes discussed in the Shared Knowledge Celebration Planning Guide, page 193. A number of the organizational Blackline Masters may be useful.
  - Use or adapt Blackline Master 1-5, Researching Using the 7Es from Unit 1, page 50.
- f. Hold a culminating activity where students can present their findings. It could be as a presentation to invited guests, such as members of the local First Nations community or another class.

### 3. BITTERROOT: A PLANTS AND PLACE EXAMPLE

Use Blackline Master 2-1 “The Bitterroot Story” to provide students an example or model of a plant study that illustrates different types of Traditional Ecological Knowledge that First Peoples have about plants growing in their territories.

- a. Depending on the class, you can read the text together, or have students read it silently.
  - Ask students to read or listen to find as many examples of traditional knowledge or understandings about the plant as they can.
- b. Ask students to create a graphic organizer or mind map to illustrate the many different types of knowledge First Peoples traditionally held about the bitterroot plant and its habitat.
  - Teacher's Notes: Some of the areas of knowledge featured in the article include: the names in the language; where, when and how to harvest the plant; how it is connected to both the cultural and physical aspects of life; how to prepare it; how to harvest sustainably and how to manage the landscape to maintain and increase the potential harvest.



## UNIT 2 • PLANTS AND THE CONNECTION TO PLACE

- Ask students if they think there is any information missing. What further questions can they think of that could tell more about how the bitterroot fit into the lives of the Interior people in the past and the present?
    - For example, the article does not discuss traditional narratives that might talk about the importance of the bitterroot.
  - Ask students to identify the parts of their graphic or map that relate to “place,” that is to the local environment and the relationships the First Peoples have with it.
- c. You may want to highlight the ways that the First Peoples traditionally used the land in sustainable ways. How did their beliefs in the interconnectedness of all things affect the way they harvest these and other plants?
- Students could find other examples of the ways First Peoples managed the landscape and harvested sustainably. (For example, in many areas of the province people used to use controlled burning to regenerate plants and revitalize the soil.)
  - Students could create a poster or a digital presentation to illustrate different ways the First Peoples traditionally managed their plant resources.
- d. Comparing nutritional value. Ask students to study the tables of nutritional values for the bitterroot and the carrot. Can they decide which plant is better for you?
- This can be an opportunity to assess students’ growth in evaluating Curricular Competencies of the Learning Standards.
  - Students should note that the bitterroot values are for the dried plant, while the carrot values are for the raw plant. Also, they may question the validity of these single sources of information.
  - Ask students to design a way to be able to more accurately compare the nutritional values in these two tables.
- e. As an English Language Arts activity, and a check on students’ understanding of the content, ask students to act as editors of the article by adding headings to break up the content into topics.
- f. Additional resources for the bitterroot.
- Teachers or older students can consult *Shuswap and Okanagan First Nation Root Food Protocols*, an informative Masters’ Thesis by a First Nations scholar, Nancy Bonneau. She studied the protocols and harvesting practices of two important plants, bitterroot and springbeauty. It contains excerpts of interviews with people who still harvest these plants today. Available online at this link <http://ow.ly/m0If302O93Y> or search on title keywords.
  - *The Gift of the Bitterroot*. As told by Johnny Arlee. This picture book includes a traditional narrative of the Salish and Pend d’Oreille First Peoples from Montana, relatives of their Canadian neighbours who also prize the bitterroot. It explains the origins of the bitterroot. A PDF version is available at the

## UNIT 2 • PLANTS AND THE CONNECTION TO PLACE



Lessons of Our Land website, <http://www.lessonsofourland.org>. The direct link is <http://ow.ly/vZ4J302OYM9>.

### 4. PLANTS AS INDICATORS

Plants are frequently used as indicators or signals of the timing of other events in First Peoples' seasonal rounds. When people notice a certain flower blooming in the spring, they can reliably predict that another important event is about to happen. For example, in the Okanagan, when the needles of the larch tree turn yellow in the fall, it indicates that the female black bears will be entering their dens.

- a. For more information and activities, see Unit 1, Traditional Ecological Knowledge, Activity 7, and Blackline Master 1-4, "Understanding Nature's Signals" on page 49.
- b. With students, find out some examples of plants as indicators in the local region. Consult Elders and knowledge keepers, as well as available print resources.
- c. Discuss with students the types of scientific knowledge and skills that are important when people use plants as indicators.
  - How does using plants as indicators demonstrate the idea of interconnectedness?
  - How do indicator plants help to create a "sense of place" for local First Nations communities?
- d. Students can represent their findings by designing a poster or informational brochure. This could be used as an assessment tool.

### 5. PLANTS IN TECHNOLOGY

Students can explore the many ways in which plants are used in sophisticated technologies, such as basket making; carving daily implements as well as ceremonial and sacred objects; rope; buildings; transportation and harvesting tools.

- a. Students can find out about the properties of the wood and other plant materials that make them useful in the many different technologies that use them.
- b. Bending Wood. Invite students to explore bending different types of wood that have been soaked in water.
  - Students can design a lab test to see how different woods do or don't bend.
  - Hold a challenge to see who can bend a piece of wood the farthest, and get it to hold its shape.
  - Students should recognize and follow safety procedures when doing this test.
  - Students may want to investigate how First Peoples woodworkers bend wood in their work. (See for example how bentwood boxes are made.)



## UNIT 2 • PLANTS AND THE CONNECTION TO PLACE

- c. Arrange, if possible, an opportunity to observe or work with a First Nations weaver use plant materials such as bark, roots and grasses.
- d. Discuss with students how continuing to use local plant resources for technologies is important for First Peoples' sense of place.

### 6. FINDING EXAMPLES OF TRADITIONAL SCIENTIFIC KNOWLEDGE

Students can hunt for examples of specific types of scientific knowledge or principles that are part of the Traditional Ecological Knowledge of plants. Although First Peoples did not traditionally use the terminology used by scientists today, such as physics, chemistry and biology, the understandings and processes are still part of the traditional knowledge.

- a. As an introduction, use Blackline Master 2-2, Traditional Knowledge About Plants.

### 7. LOCAL PLANTS FOR TEA

Ask students to find out about local plants that can be used for making tea. You may want students to use the Wild Tea Fact Sheet, Blackline Master 2-3, to gather information.

- a. If possible, invite an Elder or other knowledge keeper to share their knowledge about local plants that can be used for making tea.
- b. Provide students research resources about local or BC plants, particularly those which describe traditional First Nations plant use.
  - *Drink in the Wild* by Hilary Stewart gives a good overview of many plants that can be used for tea. Although there are some notes regarding First Nations use, it does not have a First Nations focus.
  - Local ethnobotany books by Nancy Turner and local experts have a great wealth of local Indigenous information. See a list in the Additional Resources below.
  - E-Flora BC: Electronic Atlas of the Flora of British Columbia may be of use to some students who can deal with a large amount of screen-based information. It includes pictures and distribution maps, but does not include Indigenous information. It also includes endangered status of each plant in BC. Online at <http://ow.ly/7e6A303qNU7> or search for keyword “eflora.”
- c. If it works for your location and time of year, take a field trip to collect leaves and fruits from native plants in your area that are suitable for making tea. This can be tied in with the visit from an Elder or other community expert.
  - Ensure students are aware of any protocols involved in harvesting from the land, as well as the normal safety factors involved in a field trip.
  - Ensure that if students do harvest plants, they do so sustainably.





- d. Alternatively, if it is not appropriate to pick wild plants because of the season, local availability, or local protocols, you may want to focus on observing the plants on your walk.
- Students could identify plants they are familiar with, and find out what others are.
  - Sketch some of the plants or take photos.

### 8. BREWING AND BLENDING TEA

Give students an opportunity to collect and make teas from local plants. Have them investigate the properties of a variety of teas and select one or two to create their own personal blend.

- a. Preparing plants to make tea. If you were able to harvest local plants for tea making, discuss with students how the plants will be prepared.
- Can the fresh leaves or other parts be used? Does it need to be dried?
  - Have students prepare plants as is appropriate.
- b. Evaluating teas. Have students work in groups to prepare samples of each of the teas that are available. They should test them according to a number of properties: physical properties, strength of the tea sample, aroma, colour astringency and flavour.
- Students could also carry out chemical tests if materials are available, including pH, Vitamin C, and sulfite testing.
  - Use Blackline Master 2-4, Blending Teas Workbook, as a guide for students to carry out the activity.
  - To adjust for older or more capable students, you may want to let them develop the criteria for evaluating the teas themselves. You could assess their ability for the Learning Standard “Choose appropriate data to collect to answer their questions.”
  - Provide appropriate materials for making the teas, including kettles, cups, and recycling container for the used plant material. Develop a procedure for students to follow when making the samples.
  - Sourcing teas. See suggestions for obtaining a variety of teas in the sidebar.
  - Recording data. Students may develop their own methods for recording their findings, or you may want to make copies of Blackline Master 2-5, Tea Testing Lab Report.
  - Research. Students can add to their lab report with information from other research, including the Wild Tea Fact Sheet and other books and resources you may have.
  - Evaluation. Students should evaluate each of the teas they have tested to decide if they are possible candidates for their tea blend, giving reasons for their decision.

In addition to local plants, here is a suggested list of other plants to use:

chamomile  
 chickweed  
 dandelion  
 ginger root  
 lavender  
 mint  
 mullein  
 pine needles  
 pineapple weed  
 sage  
 wild rose  
 white tea







## UNIT 2 • PLANTS AND THE CONNECTION TO PLACE

- c. Blending teas. Have students work on their own to decide on their personal tea blend.
- See part 2 of Blackline Master 2-4. Blending Teas Workbook. Students should decide on the proportions of the teas they are blending, and what quantity to use.
  - Encourage students to try variations of their blends (within reason depending on the supplies that are available). What variables could they change in subsequent trials? This could be used to assess the Science Learning Standard *Decide which variable should be changed and measured for a fair test.*
  - Ask students to complete a reflection on their final blend, using Blackline Master 2-6, Blending Teas Journal Reflection.
- d. Sharing Tea blends. Decide how students will share their final tea blend. This could be a classroom sharing session, or an event where community members are invited for tea. Depending on the supplies available, students may be able to take samples of their teas home to share with their family.
- Packaging tea. Decide if the tea will be kept loose, or if students will make tea bags to take home.
- e. Other Tea Activities
- Solutions and Mixtures. Is tea a solution or a mixture? Ask students to work in groups to prove if tea is a solution or a mixture.
    - Discuss what they will need to know to find an answer. (You may need to teach the concepts of solutions and mixtures if you haven't done so, or challenged students to discover what these scientific words mean for themselves.)
    - Guide students to understand the different properties of solutions and mixtures.
  - From Seed to Cup. Students can grow plants from seeds or cuttings and pick leaves from the plant once it is grown to make tea; this will give an appreciation for the plant by nurturing it and watching it grow and being able to enjoy the tea that can be made from the leaves.
    - Students can compare this to the collecting of local plants by First Peoples and the making of traditional teas.



## Assessment

Here are some suggestions for assessing the Essential Questions of the unit. See general suggestions for assessment in the Introduction, page 24.

1. How can humans interact with plants in a respectful and sustainable manner?
  - a. Check students' attitudes towards respecting the environment through informal observation and questioning during activities, such as during visits by guest speakers, on a nature walk, during inquiry activities and during tea making activities.
  - b. During one or more of the activities, ask students to construct a cause and effect chart showing what happens during a respectful or sustainable interaction with plants, and a disrespectful or unsustainable interaction with plants.
2. How have First Peoples used their knowledge of plants and their habitats for survival and well-being?
  - a. As students progress through the unit, ask them to record examples of how plants contribute to survival and well-being of First Peoples. This could be in their journals, or on chart paper shared by the class.
  - b. Have students create a lesson to teach a younger class about how traditional knowledge about plants helped the local First Peoples survive in the past.
3. How do First Peoples' perspectives on interconnectedness and place reflect their understandings about plants and their habitats?
  - a. Have students draw a picture or a diagram that shows how one plant is connected to other aspects of the natural world and to many parts of the lives of First Peoples.
  - b. Ask students to create a display that shows the interactions and connections between local plants and their habitats.

## Additional Resources

Bibby, Maureen and Teresa Laplante. *Ktunaxa Resource Kit Teachers Guide*. Ktunaxa/ Kinbasket Language Program. 1994.

These lesson activities include Plant Collecting, Hunting and Fishing, In Camp Activities and Transportation.

Bonneau, Nancy. *Shuswap and Okanagan First Nation Root Food Protocols*. Masters Thesis, Simon Fraser University. 2003. Available online at <http://ow.ly/m0If302O93Y> or search on title keywords.

A study by a First Nations scholar into the harvesting and protocols of two important plants, bitterroot and springbeauty. Contains excerpts of interviews with people who still harvest these plants today.



## UNIT 2 • PLANTS AND THE CONNECTION TO PLACE

*First Nations Traditional Foods Fact Sheets*. First Nations Health Authority. Copies may be ordered from the First Nations Health Authority, or downloaded at [http://www.fnha.ca/Documents/Traditional\\_Food\\_Fact\\_Sheets.pdf](http://www.fnha.ca/Documents/Traditional_Food_Fact_Sheets.pdf)

32 page brochure detailing many of the traditional foods from the land and sea, including harvesting methods and nutritional information.

Marshall, Amanda L. *Culturally Modified Trees of the Nechako Plateau: Cambium Utilization Amongst Traditional Carrier (Dakhel) Peoples*. M.Sc. Thesis, Simon Fraser University, 2002.

<http://www.collectionscanada.gc.ca/obj/s4/f2/dsk4/etd/MQ81889.PDF> [search on keywords Nechako plateau Marshall]

This study combines oral histories with archaeological data of CMTs in the Dakhel traditional territories. Includes ten transcripts of Dakelh elders discussing traditional uses of inner bark as a food resource. They also encompass other aspects of TEK. Chapters on the study of CMTs may also be useful.

McLeod, Elaine. *Lessons from Mother Earth*. Groundwood, 2002.

In this picture book, Tess learns from her grandmother that her garden is all of nature. As they pick plants and berries, they do so carefully and with respect. Tess discovers that if she cares for the Earth, it will provide for her just as it provided for generations past.

Parish, Roberta. *Tree Book: Learning to Recognize Trees of British Columbia*. Partnership Agreement on Forest Resource Development. Print version, or download online at <http://ow.ly/7DLO302Wa1h>.

This book details 40 trees native to BC. It included an identification key and information about each tree, including its habitat and First Nations uses.

Pasco, Juanita. *The Living World. Plants and Animals of the Kwakwaka'wakw*. Alert Bay: U'mista Cultural Society, 1998

101 plants and animals used by the Kwakwaka'wakw, with pictures, descriptions and explanations of their importance.

Port Simpson Curriculum Committee. *Port Simpson Foods*. Prince Rupert, BC: People of Port Simpson and School District No. 52, 1983.

Information and activities about 60 different plants and animal resources traditionally used by the Tsimshian people. Includes line drawings of each species.

Stewart, Hilary. *Cedar: Tree of Life to the Northwest Coast Indians*. Vancouver, B.C.: Douglas & McIntyre, 1984.

Detailed study of the many ways that cedar is used by BC First Nations. Includes many diagrams and illustrations.

Stewart, Hilary. *Drink in the Wild: Teas, Cordials, Jams and More*. Vancouver: Douglas & McIntyre, 2003.

This book gives clear instructions on how to prepare teas using many BC plants.



Thompson, Judy. *Traditional Plant Knowledge of the Tsimshian*. 2003.

<http://www.ecoknow.ca/curriculum.html>

Students apply understandings of Traditional Ecological Knowledge to plant identification, classification, traditional cultural practices and nutrition.

Turner, Nancy J. *Food Plants of Coastal First Peoples*. Royal British Columbia Museum Handbook series. UBC Press. 1995.

Turner, Nancy J. *Food Plants of Interior First Peoples*. Royal British Columbia Museum Handbook series. UBC Press. 1997.

Turner, Nancy J. *Plant Technology of First Peoples in British Columbia*. Royal British Columbia Museum Handbook series. UBC Press. 1998.

Turner, Nancy J. *Plants of Haida Gwaii*. Winlaw, B.C.: Sono Nis Press. 2005.

Turner, Nancy J. and Richard Hebda. *Saanich Ethnobotany: Culturally Important Plants of the WSÁNEĆ People*. Royal BC Museum, Victoria, BC. 2012.

Turner, Nancy J. *The Earth's Blanket, Traditional Teachings for Sustainable Living*. 2014.

Turner, Nancy J. *Ancient Pathways, Ancestral Knowledge*. Volumes 1 and 2. McGill-Queen's University Press, 2014.

An extensive study of how knowledge of plants and environments has been applied and shared over centuries and millennia by Indigenous peoples

Walker, Donna. *First Nations Science & Ethnobotany Unit K-10*. Vancouver Island Region for Aboriginal Education. N.d.

15 activity cards with science and art activities including these plants: salal, miner's lettuce, cow parsnip, salmonberry, sweet camas, red laver, chanterelle mushroom, sphagnum moss, ferns, white fawn lily, lodgepole pine and red cedar, red alder, kinnikinnick, eel grass and oregon grape, cat tails.

Lesson topics: Berries (K-7); Characteristics of Plants (K-1); Science Ecology - technology & resource use (8); Life Sciences -fishing technology; Medicinal plants (Sitka spruce, stinging nettles); Plant Identification (ethnobotany field trip); seasons (primary); simple machines and raising a post.



## The Bitterroot Story

**B**itterroot is a perennial plant that grows in dry habitats of the Interior Plateau region of BC. Through most of the year it is hard to see among the grasses and sagebrush that dominate the landscape.

But each April or May, it comes to life for a few short weeks. Bright pink flowers blanket the earth with colour. That is why some people call the plant “desert rose.” Soon, however, the plants dry out and are hidden from view once again.

For thousands of years, bitterroot has been one of the most important plants for First Peoples who live in the driest regions of the BC Interior, including the Ktunaxa, Nlaka’pmx, Okanagan, Secwepemc and Sinixt. They were also important to their neighbours who live in what is now the United States. Part of their Traditional Ecological Knowledge was the high nutritional value of the bitterroot.

The roots are harvested just before the flowering stage, so people have to be able to judge when the roots will be in their best condition. Traditionally it was the women’s role to dig them out of the ground using a digging stick, although in more recent times, all the family may participate.

In most communities, a special ceremony takes place at the beginning of the harvest, sometimes called the First Root ceremony. When the Elders determine that the plants are ready, the first roots of the season are dug, and shared with the community, often at a feast.

Protocols vary by community, but usually

### **Nlaka’pmx**

*ʔqwepn* (pierced by stick or sharp instrument)

or *sp’itl’m*

A related word *pítl’m* means ‘rub bitterroot on rough rock to remove skin’

### **Okanagan**

*sp’itl’m* - known as Chief Bitterroot

For the Okanagan, bitterroot is “the Chief for things under the ground.”

### **Secwepemc**

*sp’itl’m* (eastern dialect)

*ʔek’wpin* (western dialect)

involve words and songs of respect and thanks given to the plant for sharing itself with people.

Soon after the roots are dug, the bitter outer skin is peeled off. Then the roots are steamed, pit-cooked or boiled. In the past, some were eaten freshly cooked, but most were dried.

The dried roots can be stored for a long time. Traditionally they were stored for winter supplies, and also for trade with their neighbours where the plant doesn’t grow.

When it comes time to eat them, the dried plants are soaked overnight. They might be added to soups. Bitterroot traditionally is often mixed with other foods such as:

- saskatoon berries and deer fat
- black tree lichen and fresh salmon eggs
- tiger lily bulbs and ripened salmon eggs
- dried gooseberries

In the past, bitterroot grew in tremendous quantities in its native habitat. One observer who visited the Fraser Canyon region 100 years ago estimated that there were millions of plants, at least 100 per square metre in places.

Women harvested large amounts of the roots in the short period that they were available. Sometimes they dug up hundreds or even thousands of roots. You can imagine the amount of work involved to peel and dry that quantity.

You might think that digging out thousands of roots would be harmful for the plants. After all, the whole plant had to be taken. However, the First Peoples always harvested the plants





respectfully. If they did not, it could endanger their survival.

Today we would say that they have always followed **sustainable management practices**.

First, their traditional knowledge would tell them if there were enough plants to harvest in large quantities. Often, they would move from one area to another from one year to the next, so a digging ground could recover.

As well, they dug the roots **selectively**. That means, they didn't clean out one area, but made sure they left enough to grow in the future.

Another method used in the past was to replant parts of the roots. This shows us that the ancient people understood that a piece of a root will grow into a new plant. Scientists call this **vegetative propagation**.

The act of digging the soil with their diggers helped to keep the soil loose so the plants could grow.

**Transplanting** was another sustainable practice applied to the bitterroot. First Peoples sometimes moved the plants from a productive area to a region where there were few plants growing. This demonstrates that part of their TEK was an understanding of habitats, and what a plant needs to survive. This is an example of how some First People's scientific practises brought about a change to the landscape.

These examples of sustainable practices were also used by First Peoples to manage other plant species.

Since colonization, the number of bitterroot plants has been seriously reduced. Many traditional sites have become cattle ranches. Overgrazing and trampling the earth by livestock have packed the soil and otherwise impacted their habitat. Also many sites have become farmland, where the natural plants have been replaced with commercial crops.

Some people still harvest and use bitterroot today. For many First Peoples in the region, it is a strong link to their culture, and helps give them a sense of belonging to the place where they live and where their ancestors once ate and traded the bitterroot in huge quantities.

### **Bitterroot, dried**

#### **Nutritional Value**

per 100 grams dry weight

calories	387
calcium (mg)	235
protein (g)	10
iron (mg)	33
carbohydrate (g)	85
magnesium (mg)	74
lipid (g)	1
zinc (mg)	5

Source: US Forest Service. <http://bit.ly/2dDBjGc>

### **Carrot, raw**

#### **Nutritional Value**

per 100 grams

calories	41
calcium (mg)	33
protein (g)	1
iron (mg)	0.3
carbohydrate (g)	10
magnesium (mg)	74
lipid (fat) (g)	2
zinc (mg)	0.24

Source: <https://authoritynutrition.com/foods>

*Compare the nutritional value of the bitterroot with that of another root vegetable, the carrot.*

Sources:

BC Ministry of Forests, Lands and Natural Resource Operations [www.for.gov.bc.ca/rsi/fnb/bitter-root.pdf](http://www.for.gov.bc.ca/rsi/fnb/bitter-root.pdf)

Bonneau, Nancy. Sushwap and Okanagan First Nation Root Food Protocols

Turner, Nancy J. *Ancient Pathways, Ancestral Knowledge*.

Turner, Nancy J. *The Earth's Blanket*.

UN Food and Agriculture Organization

[www.fao.org/wairdocs/other/ai215e/AI215E06.htm](http://www.fao.org/wairdocs/other/ai215e/AI215E06.htm)

## Traditional Knowledge about Plants

These are some pieces of scientific knowledge that First Peoples have known about plants since Time Immemorial. What other understandings can you add to the list?

### **Edible roots such as camas, balsamroot**

Traditional knowledge:

Slow cooking makes the roots more digestible, more nutritious and sweeter.

In the past these roots were very important food items for many First Peoples. However, they contain inulin, a type of sugar that people can't digest. Slow cooking converts the complex sugars to the more digestible fructans and fructose.

While First Peoples don't use these chemical names, they have always understood the properties of the plant. To prepare the roots for eating, they traditionally cook them very slowly in a pit for a day or more to produce a sweet nutritious food.

### **Properties of different types of wood**

Traditional knowledge:

Different species of trees produce wood with unique properties that can be used for different purposes..

Traditional understandings of what type of wood to use in a certain situation is an important part of Traditional Ecological Knowledge. This includes properties such as strength, durability and density. People know that western red cedar can be split cleanly along the grain, and that it can be bent and hold its shape by steaming. They know certain woods such as mountain alder are strong but flexible, so make good bows and snowshoes.

### **Strong fibres from plants**

Traditional knowledge:

Some plants contain strong fibres that can be used for things like fabric, nets and rope.

Some plants such as stinging nettles contain fibres that can be processed for many uses. Using the fibres requires many types of knowledge, such as when to harvest it safely, how to process the plant to extract the fibres and how to spin a strong fibre.

### **Preserving berries by drying**

Traditional knowledge:

Dehydration allows plants to be preserved for long periods of time.

All types of berries can be preserved by drying in the sun or wind. Traditionally berries were often cooked, mashed and spread on a mat to dry. The dried cakes had to be stored properly so they did not reabsorb water. When it was time to eat them, the berries could be eaten dried, or rehydrated.



# WILD TEA FACT SHEET

## NAMES FOR THE PLANT

Local First Nations Name

Common Name

Scientific Name

## HABITAT

Where does this plant live?

## HARVESTING

When is the best time of year to pick it?

## BENEFICIAL PROPERTIES

What are some good health and nutritional properties?

## WARNINGS

What are some things to be careful of when using this plant?

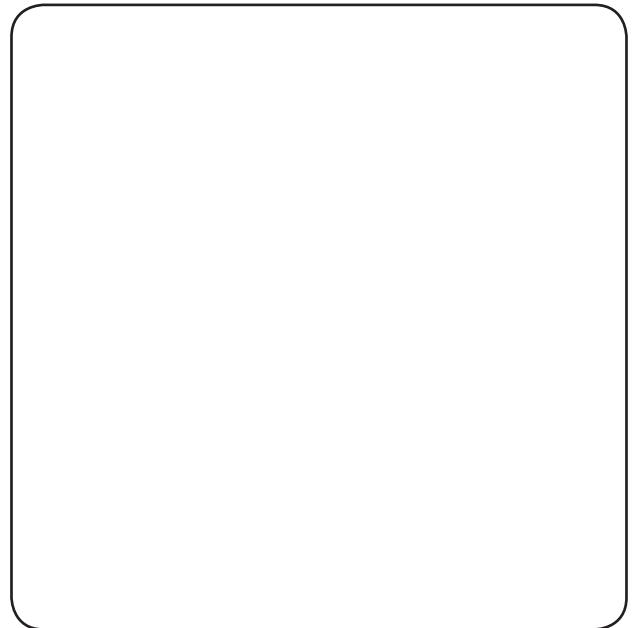

Picture of plant

## PREPARATION

How can you make tea with this plant?

## OTHER USES

What are other ways this plant can be use?

# Blending Teas Workbook

**Goal:** To create your own blend of teas

## 1. Tea Tasting

To begin, test a variety of teas to see which ones you would like to blend.

- Work with your group to prepare samples of the teas supplied to you. Follow procedures outlined by your teacher for safely preparing and tasting samples.
- Test the samples, looking for the following properties:
  - Physical Properties (the look and feel of the leaves or other plant parts used)
  - Strength of the tea sample
  - Aroma
  - Colour
  - Astringency
  - Flavour
  - Chemical Properties: Your teacher will suggest chemical tests that are available.
  - Research Result: Add other information to your report, such as nutritional content, origin of the plant, and cultural significance.
- Record your results in your notebook or on the Tea Testing Lab Report handout.
- Evaluate the sample. Decide if you would consider using this plant for your tea blend, and give your reasons why or why not.

### Safety Alert

List some risks that might arise when you are making, testing and blending tea.



## 2. Blending

Once your group has completed testing the samples, decide which two or three teas you will use for your own personal blend.

- Decide what proportions of each tea you will use in the blend. Will you use them in equal measure, or will you make one the base?
- Tea trials: Make a test brew of your blend, then taste it. Do you like it? If not, try different proportions of the teas or change the length of time you brew it.

## 3. Reflection

Once you have decided on your final blend, complete the Blending Teas Journal Reflection handout.

- How did you handle the risks in this activity? Do a self-assessment.

### Recycle

Make sure you put the used plant material in the compost or organic recycle so it can be returned to the land!

# Tea Testing Lab Report

**Plant Name:**

**Physical Properties**

Describe the look and feel of the leaves or other plant parts used for the tea.

**Strength of tea tested**

How strong was this tea sample?  
weak    moderate    strong    very strong

**Aroma**

Describe the aroma of the brewed tea, and also the tea leaves after they have been brewed.

**Colour**

Describe the colour of the brewed tea.

**Astringency**

none    low    moderate    high

**Flavour**

Bitter    Earthy    Floral  
Medicinal    Sweet

Other (describe)

**Chemical Properties**

pH

Other chemical test results:

**Research Results**

What other important properties did you find out from research? For example, nutritional content, origin of the plant, cultural significance.

**Evaluation**

Would you use this tea in a blend? Why or why not?

## Blends from the Land: Journal Reflection

**Name of blend:**

(create a name that reflects the blend of ingredients and properties)

**Ingredients and measurements:**

**Properties of ingredients:**

**Harvesting practices:**

**Steeping time (minutes)** \_\_\_\_\_

**Served:** Hot Cold Room Temperature

**Description when ready:**

**Taste:** Bitter Sweet Floral Medicinal

**Other comments:**

**What questions do I have about my blend?**

# UNIT 3

## POWER FROM THE LAND

### Introduction

We can't usually see energy, touch it or hold it in our hands, but energy is everywhere. We use energy in all its forms every day. Scientists describe energy as the ability to do work or cause change. Work is the application of a force through a distance.

Humans have always used their ingenuity and creativity to use the principles of force and work through the creation of technologies. They use technology in diverse ways to achieve a mechanical advantage, whereby force can be increased or its direction changed.

Scientists describe the basic building blocks of technology as simple machines. They are the lever, inclined plane, wedge, wheel and axle, pulley and screw.

First Peoples have always utilized natural resources to create sophisticated technologies. Their use of these technologies demonstrates their understanding and use of scientific principles of the transformation of power and energy, and their force effects.

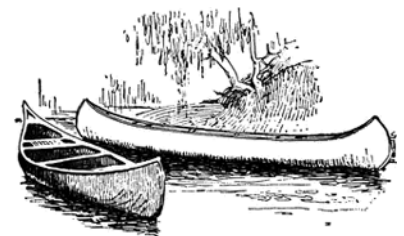



## First Peoples Connections

In the past, the skilled use of a variety of technologies was crucial to the survival of First Nations. Their understanding of the construction and use of tools can be considered part of their Traditional Ecological Knowledge. Some of the key cultural connections included in this unit are:

- Importance of names: Canoes and houses, among other things, are considered living beings, and often are named. Traditional place names often reflect technology, including where resources were found, or other places such as canoe crossings.
- Living languages: The diverse languages of BC First Nations have specific words for technological items and processes. New words are created to adapt as society changes.
- Continuity of use of tools: Many traditional tools such as the adze are still important for Indigenous carvers today. At the same time, they use modern tools as well. They know which is the best tool to use.
- Importance to cultural revival: Canoes play an important role in renewing a strength of pride among First Nations and an awareness among others. For example, each summer coastal people in BC, Alaska and Washington participate in Tribal Canoe Journeys. Other events related to canoes occur throughout the province. Recent projects have helped Elders pass on their canoe building skills to youth.

## Enduring Understandings

- First Peoples developed technologies for building canoes and houses that were ideally suited to their local climate and environment.
- First Peoples demonstrated that they understood the transfer of energy by the choices they made in the way they designed, chose materials and built items such as canoes, paddles and houses.

## Essential Questions

- How do traditional technologies reflect the land and resources of individual First Nations?
- How do traditional First Peoples' technologies demonstrate an understanding of energy, power and force?



## PLANNING TO TEACH THE UNIT

*Power and the Land* explores First People's technology in the past and present, incorporating the scientific concepts of power, force and energy. The activities will help build an understanding of the knowledge and skills First Peoples had and still have to use the resources of the land in their technologies. It is most applicable to the Learning Standards in Grades 5 and 6, but can be adapted for other grades. The unit has three sections.

### Outline of Activities

#### *PART ONE: PADDLE POWER*

These activities investigate how a paddle moves a canoe.

1. Engaging Interest
2. Investigating How Paddles Work
3. Explaining Force
4. Explaining Levers
5. What Type of Lever is a Canoe Paddle?
6. Properties of Canoe Paddles
7. Using Paddles and Canoes
8. Design a Paddle Test

#### *PART TWO: TOOLS FROM THE LAND*

This section examines tools used by First Nations in the past and present, the resources used to make them, and how they employ simple machines.

1. Thinking About the Inquiry Question
2. Investigating Traditional Tools
3. Local Tool Kit

#### *PART THREE: ANCIENT ARCHITECTS*

This part looks at how First Nations people in the past built houses, the tools they used and how their understanding of principles of force and energy were crucial to their success.

1. Developing an Inquiry Question
2. Deciding on a Question
3. Exploring the Question
4. Final Answer
5. Assessing the Inquiry





Curriculum Connections	
Suggested Topics and Inquiry Questions	Learning Standards Selected Curricular Competencies and suggested Content Standards. Other Learning Standards may also be applicable.
<b>Science 5</b>	
<p>Ways that First Peoples apply power and force in their traditional technologies</p> <ul style="list-style-type: none"> <li>• In what ways do traditional First Peoples' technologies demonstrate their understanding of power and force?</li> <li>• How do traditional tools used by First Peoples in the past use simple machines to transfer force and energy</li> </ul>	<p><i>Curricular Competencies</i></p> <p>Identify First Peoples' perspectives and knowledge as sources of information</p> <p>Express and reflect on personal, shared, or others' experiences of place</p>
	<p><i>Content</i></p> <p>Properties of simple machines and their force effects</p> <p>Machines: constructed, found in nature</p> <p>Power - the rate at which energy is transferred</p>
<b>Science 6</b>	
<p>Ways that First Peoples apply the principles behind Newton's laws of motion in their traditional technologies</p> <ul style="list-style-type: none"> <li>• In what ways do traditional First Peoples' technologies use the principles of motion?</li> <li>• How do some traditional technologies use the force of gravity?</li> <li>• How can you demonstrate or model a traditional technology that uses the principles of motion?</li> </ul>	<p><i>Curricular Competencies</i></p> <p>Identify First Peoples' perspectives and knowledge as sources of information</p> <p>Communicate ideas, explanations and processes in a variety of ways</p>
	<p><i>Content</i></p> <p>Newton's three laws of motion</p> <p>Force of gravity</p>



## Cross Curricular Links

### *SOCIAL STUDIES*

These activities may be correlated with Social Studies Content Learning Standards that deal with the use of resources:

SS 4:

- The history of the local community and of local First Peoples' communities
- The impact of colonization on First Peoples' societies in British Columbia and Canada

SS 5:

- First Peoples' land ownership and use

SS 7

- Human responses to particular geographic challenges and opportunities, including climates, landforms, and natural resources

### *ENGLISH LANGUAGE ARTS*

Traditional narratives and texts that knowledge about traditional technologies can be used in parallel with Science classes, meeting the relevant First Peoples-related Curricular Competencies. For example:

ELA 5:

- Demonstrate awareness of the oral tradition in First Peoples' cultures and the purposes of First Peoples' texts
- Identify how story in First Peoples' cultures connects people to land

ELA 6, 7, 8, 9:

- Recognize and appreciate the role of story, narrative, and oral tradition in expressing First Peoples' perspectives, values, beliefs, and points of view

ELA 7:

- Recognize the validity of First Peoples' oral tradition for a range of purposes

ELA 8:

- Develop an awareness of the protocols and ownership associated with First Peoples' texts

ELA 9:

- Develop an awareness of the diversity within and across First Peoples' societies represented in texts

**PART ONE**  
**PADDLE POWER**

**Question for Inquiry**

How does a paddle move a canoe?

**Suggested Resources**

- pictures and videos of people paddling canoes
- one or more longboards or skateboards (invite students to bring them to class)
- wooden or metal poles, paddles
- resistance bands
- Blackline Master 3-1, Parts of a Paddle, page 97
- Blackline Master 3-2, Paddle Blade Styles, page 98
- Canoe templates, Blackline Master 3-3 to 3-6, page 99 to page 102

**Suggested Activities**

*1. ENGAGING INTEREST*

- a. Begin with one or more activities which capture students' interest in canoes and paddles, and which illustrate paddles in action. The form this takes will depend on available resources, location and time of year. Some possible introductory activities are:
  - A field trip to view or participate in a canoe being paddled in the water.
  - A classroom visit by an experienced puller who can demonstrate and discuss paddling and canoes.
  - A classroom visit by a First Nations carver who has built canoes and paddles.
  - A video of canoes in action.
  - A display with one or more paddles and photographs of canoes in action.
- b. Ask students about their knowledge of canoes and paddling. Have they had any experiences with travelling in a canoe? What do they know about First Nations canoe used in the past and present?
- c. You may want to use Blackline Master 3-1 to have students identify the parts of a paddle.
- d. Pose the question "How does a paddle move a canoe?" Students may record their responses or the teacher may record them on chart paper to refer to later.



2. INVESTIGATING HOW PADDLES WORK

- a. Use skateboards to simulate paddling a canoe. One student stands on a skateboard and uses a pole to propel themselves forward, with one hand at the top of the pole, and the other in the centre, as if holding a paddle.
  - One or two other students act as spotters to ensure safety.
  - Allow students time to take turns “paddling” and spotting.
  - Ask students to think about the energy used in moving the skateboard. Where does the energy come from? How is it transformed?
  - Suggest students try variations: changing body position, holding the pole at different places, changing sides, only using one hand, pushing harder. How do these changes affect the motion?
  - For a fun activity, have skateboard poling races.
  - Some considerations for conducting this activity:
    - Divide students into groups according to the number of skateboards and poles available.
    - Select an appropriate location to do the exploration. Riding skateboards in the classroom may not be appropriate!
- b. Record observations. In their groups, have students record what they observed when they moved a skateboard with a pole. Groups can then report back to the class to compare experiences.
- c. Lead a discussion with the question, “How does moving a skateboard help us understand how a paddle moves a canoe?”
  - Talk about the similarities and differences between poling a skateboard and paddling a canoe.
- d. Provide students an opportunity to analyse how paddles are used. (This may have already been included in Activity 1.) Have students view video clips to observe the action pullers use when paddling a canoe. For example, see the short Youtube clip *Spirit Canoe in Slow Motion* (<http://bit.ly/2drj7nf>)
- e. Ask students to draw a diagram that shows how they think a paddle moves a canoe.
- f. Assess students’ attention to safety when using the skateboards, to meet the Curricular Competency, “Use equipment and materials safely, identifying potential risks.”



## UNIT 3 • POWER FROM THE LAND

### 3. EXPLAINING FORCE

- a. Ask students to share their diagrams from Activity 2(e) with a partner or in a group to explain how the paddle moves the canoe. What different ideas emerge? Have students share their explanations with the class.
- b. Leading on from the students' ideas, introduce the scientific term “force,” which means a push or a pull.
- c. Discuss how a paddle uses force to move the canoe. How is energy transferred? What will happen if a puller paddles harder? How does having many pullers in a canoe make it go faster?
- d. Teacher's Notes

Force is a push or a pull resulting from an interaction between two objects. Force only exists when there is an interaction. The amount of force can be measured, and it has direction. In the case of the paddle, it is the interaction of the paddle and the water. When the paddle is pulled backwards through the water, the canoe moves forward. It is an example of Newton's Third Law of Motion: Every action has an equal and opposite reaction.

### 4. EXPLAINING LEVERS

- a. Have students work in pairs to demonstrate how a paddle exerts force.
  - The students put the pole or paddle through the loop on a resistance band.
  - One student holds the pole or paddle, while the other stretches out the resistance band in front.
  - The puller makes a paddling motion, with the bottom hand placed at different spots along the shaft, e..g. near the top, lower.
  - Students observe how the placement of their hands affects the force the paddle exerts on the resistance bands.
  - Have students draw the most efficient place or places to hold a paddle.
- b. Display a number of classroom items that are examples of levers, and/or show pictures of other real life examples.
- c. Ask students “What do these objects have in common with a canoe paddle?”
  - Suggest students think about the force that is applied and what happens to it.
  - List the properties students provide on the board.
- d. Have students take a ruler and eraser (or other object for a fulcrum), and demonstrate how they can apply the same properties to lift a book or other object.
- e. Introduce the terms lever and fulcrum, input effort, output effort, load.
- f. Discuss the three classes of levers according to placement of the fulcrum. Identify which class of lever the example objects belong to.



### 5. WHAT TYPE OF LEVER IS A CANOE PADDLE?

Ask students to work in pairs or groups to decide what class of lever they think a canoe paddle belongs to. Have them give their reasons why they chose this class, and draw a diagram to illustrate it (or add labels to earlier diagram).

#### a. Teacher's Note

There is no agreement on what type of lever a canoe paddle is. It depends on where you consider the fulcrum to be. It is often given as an example of a second class lever, with the fulcrum being the blade of the paddle in the water. Others consider the top hand to be the fulcrum, making it a third class lever. This is a good opportunity for a discussion about how, in science, there isn't always one right answer, and trying to answer one question leads to further questions.

### 6. PROPERTIES OF CANOE PADDLES

Paddle makers in the past and the present create paddles which are well-suited to their use and environment. Ask students to investigate different styles of paddles to determine the design choices paddle creators make.

#### a. Students research different paddle blade designs.

- Use images of paddles in books, photos and videos. Students can draw the different styles.
- For a good photograph of different paddle styles see pages 52-53 of David Neel's book *The Great Canoes*. Alternatively you can use the paddles blade styles shown on Blackline Master 3-1, page 98.

#### b. Ask students to predict which style of paddle they think would be the most powerful and explain why.

#### c. Have students suggest why paddle makers might use some of the different shapes.

- Some of the properties they can consider are strength, thrust, comfort, flexibility, ease of water entry, intended use of the paddle.

### 7. USING PADDLES AND CANOES

Ask student to research the ways canoes were used in the past and how they are used in the present. Consider questions such as:

- What types of canoes are used in the local area? How are they different from canoes in other parts of the province, country and world?
- What materials were used to make the canoes and paddles? Why were these materials chosen?
- What were some of the skills required to build canoes and paddles?

#### a. If possible invite a knowledgeable community member to speak about local types of canoes, and if any are in use today.



UNIT 3 • POWER FROM THE LAND

- b. Develop this into a research project which could include final products such as models, dioramas, posters, written report.
- c. Include an investigation of other cultural aspects of the canoe and paddle.
- d. Develop an inquiry question that looks at the science of canoes, such as how does the design of a particular canoe help its function?
- e. Students may use the canoe templates on Blackline Masters 3-3 and 3-6 to demonstrate different styles of canoes. You may want to enlarge the templates on the photocopier.

8. *DESIGN A PADDLE TEST*

This activity has two possible parts, but only the first part may be feasible to carry out. Part one would be to design an experiment, and part two would be to build and test it.

Inquiry question: How could you prove which type of paddle has the most power?

- Students should refer back to the predictions they made previously.
- Students should be able to understand and use the terms force, energy and power in their design.
- If students don't come up with the idea themselves, you may want to suggest that they don't necessarily need to use full size paddles; scientists often use models to answer problems.





## Part Two

### Tools from the Land

This section is an investigation of the diverse tools First Peoples used in their traditional technologies, including the natural resources used to make them, and how they employ simple machines.

### Question for Inquiry

How did First Peoples' tools from the past use simple machines to transfer force and energy?

### Required Resources

- Examples and pictures of traditional First Peoples' tools, including adzes, wedges, axes, chisels, drills, tweezers, tongs, spindle whorls, arrow heads
- Blackline Master 3-7, Traditional Tools, page 103.
- Reference materials for students to research tools, including books and online resources.

### Suggested Activities

#### 1. THINKING ABOUT THE INQUIRY QUESTION

Present students with the inquiry question “How did First Peoples' tools from the past use simple machines to transfer force and energy?”

- a. Lead a discussion about how the question could be answered.
  - Ask students what they need to know to answer the question.
  - What do they already know, and what do they need to find out?
- b. As a formative assessment, informally assess students' ability to identify questions to answer through scientific inquiry.

#### 2. INVESTIGATING TRADITIONAL TOOLS

Provide students with opportunities to explore some of the tools used by First Peoples in the past, both in your local area and in other parts of the country.

- a. Some suggestions:
  - Invite a local carver or cultural expert into the class to demonstrate some of their tools.
  - Visit a local museum to view tools on display. Many museums offer school programs which could be adapted to the topic of tool technology.



## UNIT 3 • POWER FROM THE LAND

- Develop a display of books and pictures that illustrate First Peoples tools. The Hilary Stewart books (*Stone, Bone, Antler & Shell; Cedar and Indian Fishing*) are probably the basic resources for coastal First Nations. See *Connecting Traditions* for information for the Secwepemc First Nation.  
<http://secwepemc.sd73.bc.ca>.
- Direct students to online sites that illustrate Indigenous technology. See suggestions in Additional Resources, below.
- Use Blackline Master 3-7, Traditional Tools. Ask students to predict what the illustrated tools might have been used for.
  - Key for the pictured tools: drill, adze, arrow or spear head, tweezers, digging stick

### 3. LOCAL TOOL KIT

What tools did the local First Nations in your community need? Ask students to work together to list the tools local First Nations used for different aspects of their lives in the past.

- a. Have students research one tool in depth. Divide the list up so at least one person or pair is researching each tool.
- b. Discuss with students the type of information they could find out about the tool. For example, materials it is made out of, parts of the tool, how it was used, how easy it was to make.
  - Discuss with students if the materials used to make the tools were from local resources or did they come from other places?
- c. Ask students to record how the tool transferred force and energy. What simple machines are the tools examples of?
- d. Discuss if these tools are still used today. Why or why not? Are any adapted to modern use?
- e. Students can present their findings on a poster or by making a replica or model of the tools with a written report.
- f. Make a display of the final products as the tool kit of the local First Nations people.

**PART THREE**  
**ANCIENT ARCHITECTS**

**Topic for Inquiry**

First Peoples successfully built houses that best suited their climate, geography and resources. The houses they built show they understood the properties of the natural materials they used, and also understood how to use the effects of force and power when they built them.

**Suggested Resources**

- Blackline Master 3-8, Scientific Inquiry Using the 7Es, page 104

**Suggested Activities**

*1. DEVELOPING AN INQUIRY QUESTION*

Present the students with the Topic for Inquiry. Tell them they are going to develop their own inquiry question to investigate this topic.

- Work with the whole class to discuss possible lines of inquiry. Encourage students to piggyback ideas off of one another.
  - Discuss with students what makes a good inquiry question. Give some examples of questions that would not be suitable. e.g. “Were houses made out of wood?”
  - Ask students to think of questions that could be answered by doing a science experiment.
- Give students an opportunity to do some initial exploration into the topic before they decide on their question.

*2. DECIDING ON A QUESTION*

Ask students to write their question. You may want students to work individually, in pairs or in groups.

- Discuss students questions with them. Are they too broad, too narrow? Do they deal with the topic? Guide students as needed to formulate their question.

*3. EXPLORING THE QUESTION*

Have students work independently to answer their question, providing assistance and encouragement as needed.

- You may want students to use the 7E model to guide the inquiry. See Blackline Master 3-8 for a template.





## UNIT 3 • POWER FROM THE LAND

- b. For other suggestions, see
- Encouraging Inquiry in the Introduction, page 21.
  - Strategies outlined in Shared Knowledge Celebration can be applied to this activity. See page 193.

### 4. *FINAL ANSWER*

Students prepare a final project appropriate to their question.

### 5. *ASSESSING THE INQUIRY*

- Check with students as they are developing their questions and give suggestions and guidance as needed.
- Students can evaluate their successful answering of the question.
- Use the final product of the inquiry as a basis for your evaluation.

## Assessment

Here are some suggestions for assessing the Essential Questions of the unit. See general suggestions for assessment in the Introduction, page 24.

1. How do traditional technologies reflect the land and resources of individual First Nations?
  - a. Ask students to create a graphic organizer (such as a T-chart) that compares traditional technologies of the local First Nation with those of a BC First Nation living in a different ecosystem.
  - b. Give students a selection of photographs and real objects of a variety of technologies appropriate to the activity or activities being pursued.
    - Ask students to explain how each technology is connected to the territory of the people who make it. This could be expressed verbally or in written form.
  - c. Have students draw a map of the local region, showing where a variety of resources can be harvested. Illustrate with drawings of the technologies that result.
2. How do traditional First Peoples' technologies demonstrate an understanding of energy, power and force?
  - a. In the course of one or more of the activities, have students draw a diagram that shows how force is applied in an application of one of the technologies. Ask them to explain how energy was transformed through the process.
  - b. Ask students to design a model that measures the force involved in a traditional technological activity.
  - c. Have students design a poster that shows how simple machines are used in First Peoples' technologies, including incorporation of energy, power and force.



## Additional Resources

*Aboriginal Culture in British Columbia*. 2011 4:32 min.

<https://www.youtube.com/watch?v=BtYHZWbw4hA>

This is a BC Tourism promotional video that might be used as an introduction to the diversity of technologies and cultures of BC First Nations.

Aboriginal Education, Kamloops School District. *Science Resources*.

Elementary: <http://sd73aboriginaleducation.weebly.com/science.html>

Secondary: <http://sd73aboriginaleducation.weebly.com/science1.html>

These two lists provide many useful resources for the Secwepemc and many other First Nations.

*Art As Culture*. Kyran Yeomans. 2012. 22 min. <https://vimeo.com/71288680>

Haida artist Kyran Yeomans directs and narrates this film which documents his father Don Yeoman's creation of a totem pole for the McMichael Art Gallery in Ontario. It has a youthful humorous style and may lead to a useful discussion about traditional and contemporary technology. Both power and traditional hand tools are used. The pole itself incorporates electronic technology, with one of the figures listening to an ipod and another using a laptop.

*Birchbark Canoes*. Dene Kede, Grade 8. Government of Northwest Territories.

Link at <http://bit.ly/2d9Koq8>

These curriculum resources are from the Northwest Territories, but can be adapted for BC.

*Canoe Designs of the Pacific Northwest*. <http://www.donsmaps.com/canoedesigns.html>

A useful web site that illustrates many types of canoes used traditionally in BC.

Clark, Karin. *First Nations in B.C.: Comparing Interior and Coastal Cultures*. Fifth edition. First Nations Education Division, Greater Victoria School District. 2002.

Teachers' resource guide with many activities for comparing interior and coastal First Nations. Specific topics on comparing environments, housing, transportation and clothing.

*Connecting Traditions*. Secwepemc Nation. <http://secwepemc.sd73.bc.ca/>

This interactive multimedia presentation gives cultural information about the Secwepemc people. For details on technology, explore the Village Life and Archeology sections. Includes transportation, tools and houses.

Evans, Doug. *Noah's Last Canoe: The Lost Art of Cree Birch Bark Canoe Building*. Winnipeg: Great Plains Publications. 2008.

The construction of a birch bark canoe in Pelican Narrows, Saskatchewan by Cree Elder Noah Custer is document through text and photographs.

## UNIT 3 • POWER FROM THE LAND



*First Voices.* <http://www.firstvoices.com>

Web-based tools and services designed to support Aboriginal people engaged in language archiving, language teaching & culture revitalization. It has online dictionaries with pronunciations for many BC First Nations languages.

*Gina 'Waadluxan Thuu / The Everything Canoe.* Skidegate: Haida Gwaii Museum Press, 2010.

An extensive look at the canoe in Haida culture, with many illustrations and photos.

Helin, Bill. *Making a Canoe.* Strong Stories series. Strong Nations Publishing, 2016

A short picture book by Tsimshian artists Bill Helin that describes the steps in making a cedar canoe.

*Hul'q'umi'num' stories: thulqushunum' | Rainbow.* Hul'q'umi'num' Language and Culture Collective. 2015. 3:10 min. <https://vimeo.com/132893949>.

Jordana Seymour and Donald White are canoe pullers in the Rainbow canoe club, Stz'uminus, BC. Delores Louie translates their story into Hul'q'umi'num'. Narration in Hul'q'umi'num' with Hul'q'umi'num' and English text.

Jennings, John. *The Canoe, a Living Tradition.* Firefly 2002.

A history of the construction and use of the canoe, kayak, dugout and umiak in North America.

*A Journey Into Time Immemorial.* Simon Fraser Museum of Archaeology and Ethnology, 2008. [www.sfu.museum/time/](http://www.sfu.museum/time/)

An interactive multimedia website based on the story of Xá:ytem Longhouse in Mission BC. Covers many aspects of Sto:lo culture including technology. For an accessible index to tool technology, go to [www.sfu.museum/time/en/sitemap/](http://www.sfu.museum/time/en/sitemap/)

Kirk, Ruth. *Wisdom of the Elders. Native Traditions on the Northwest Coast.*

Douglas & McIntyre 1986.

This book is about the cultures of the Nuu-chah-nulth, Kwakwaka'wakw and Nuxalk peoples. Some of the relevant content includes: Houses, p105-108; Tools 112-113; Canoes, 115-118.

Nabokov, Peter and Robert Easton. *Native American Architecture.* Oxford University Press, 1989.

A detailed examination of the architecture of First Nations house architecture across North America.

Neel, David. *The Great Canoes: Reviving a Northwest Coast Tradition.* Douglas & McIntyre 1995.

This book includes 70 photos with words from elders, builders, paddlers, chiefs and young people, documenting the canoe gatherings of the 1990s.



## UNIT 3 • POWER FROM THE LAND

*Northwest Coast Canoes.*

[https://www.sfu.ca/brc/art\\_architecture/canoes.html](https://www.sfu.ca/brc/art_architecture/canoes.html)

This web site from the Bill Reid Centre details all aspects of making the Northwest coast canoe.

*Northwest Coast Native Paddle Making.* 2012. 8:18 min. <http://bit.ly/2drhIgg>  
Coast Salish carver Sean Peterson of the Puyallup tribe demonstrates contemporary process of carving a paddle, using hand and power tools.

Peterson, Shaun. *Adzes and knives.* 2008. <http://bit.ly/2cL1LyD>

Puyallup/Tulalip carver Peterson describes his carving tools in this personal video.

Reid-Stevens, Amanda. *The Canoe He Called Loo Taas.* Benjamin Brown Books, 2010.

A picture book about Haida artist Bill Reid building the canoe named Loo Taas.

*Spirit Canoe in Slow Motion.* 2012. 1:41 min. Youtube link at <http://bit.ly/2drj7nf>  
A short video taken from the bow showing pullers paddling in time on the last day of 2012 Pulling Together Canoe Journey, SD 46 Sunshine Coast.

Stewart, Hilary. *Cedar: Tree of Life to the Northwest Coast Indians.* Vancouver, B.C.: Douglas & McIntyre, 1984.

Detailed study of the many ways that cedar is used by BC First Nations. Includes many diagrams and illustrations.

Stewart, Hilary. *Stone, Bone, Antler and Shell. Artifacts of the Northwest Coast.* Douglas & McIntyre, 1996.

Detailed study of the many ways that stone, bone and other materials were and are used by BC First Nations. Includes many diagrams and illustrations.

Warner, Graham and David Gidmark. *Canoe Paddles, a complete guide to making your own.* Firefly 2001.

A comprehensive guide to the history and construction of paddles, including many Indigenous examples.

## Parts of a Paddle

Label the paddle with these terms:

blade  
grip  
neck  
shaft  
shoulder  
tip

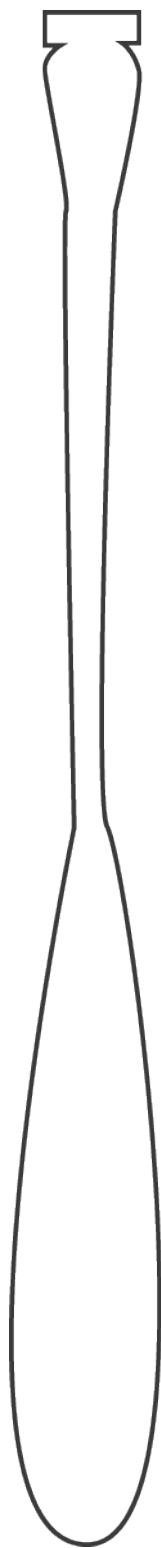

# Paddle Blade Styles



straight sides, pointed



beavertail, pointed



straight sides, rounded



beavertail, elongated



dome-sided



ottertail



concave shoulder,  
pointed



willow leaf

# South Coast Style Canoe

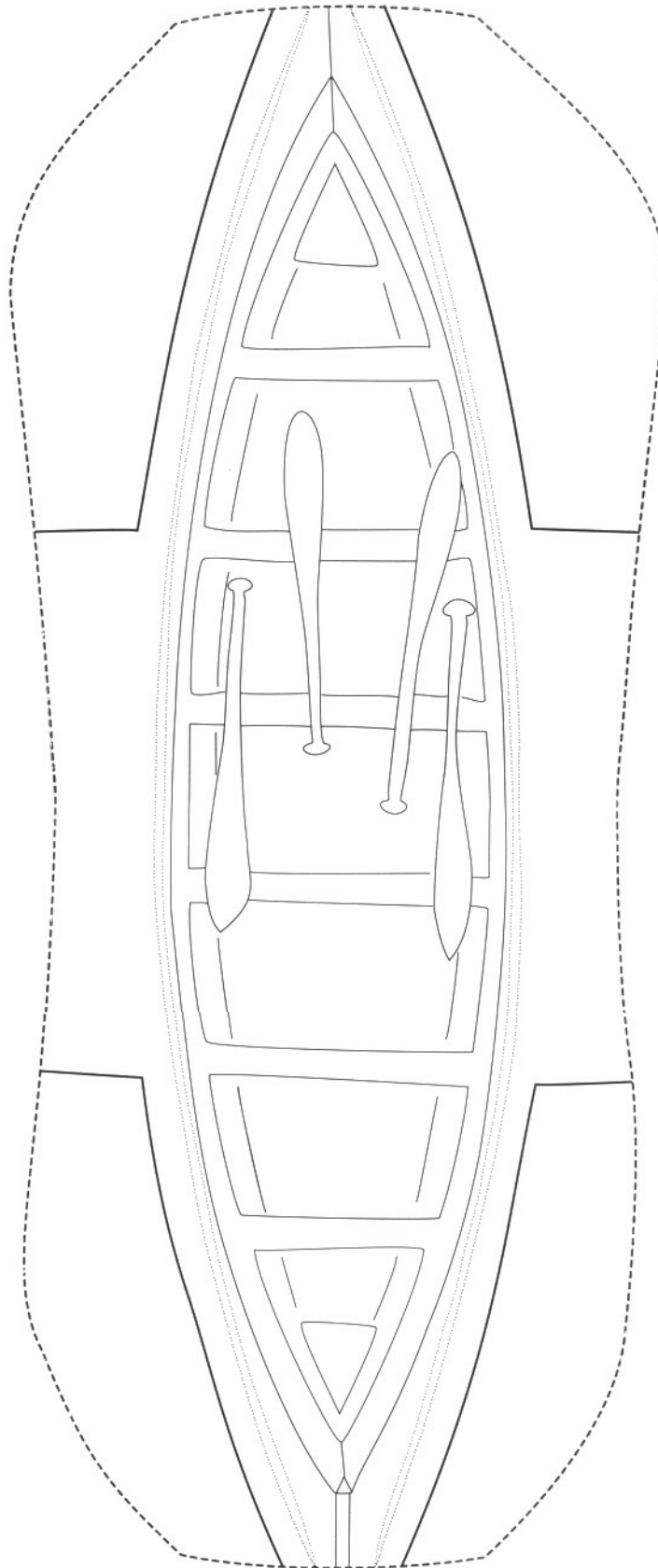

1. Cut out the shape carefully along the outer line.
2. Fold along the double dotted line to form the sides of the canoe.
3. Glue the two sides at one end to make the bow and the other end to make the stern.

# North Coast Style Canoe

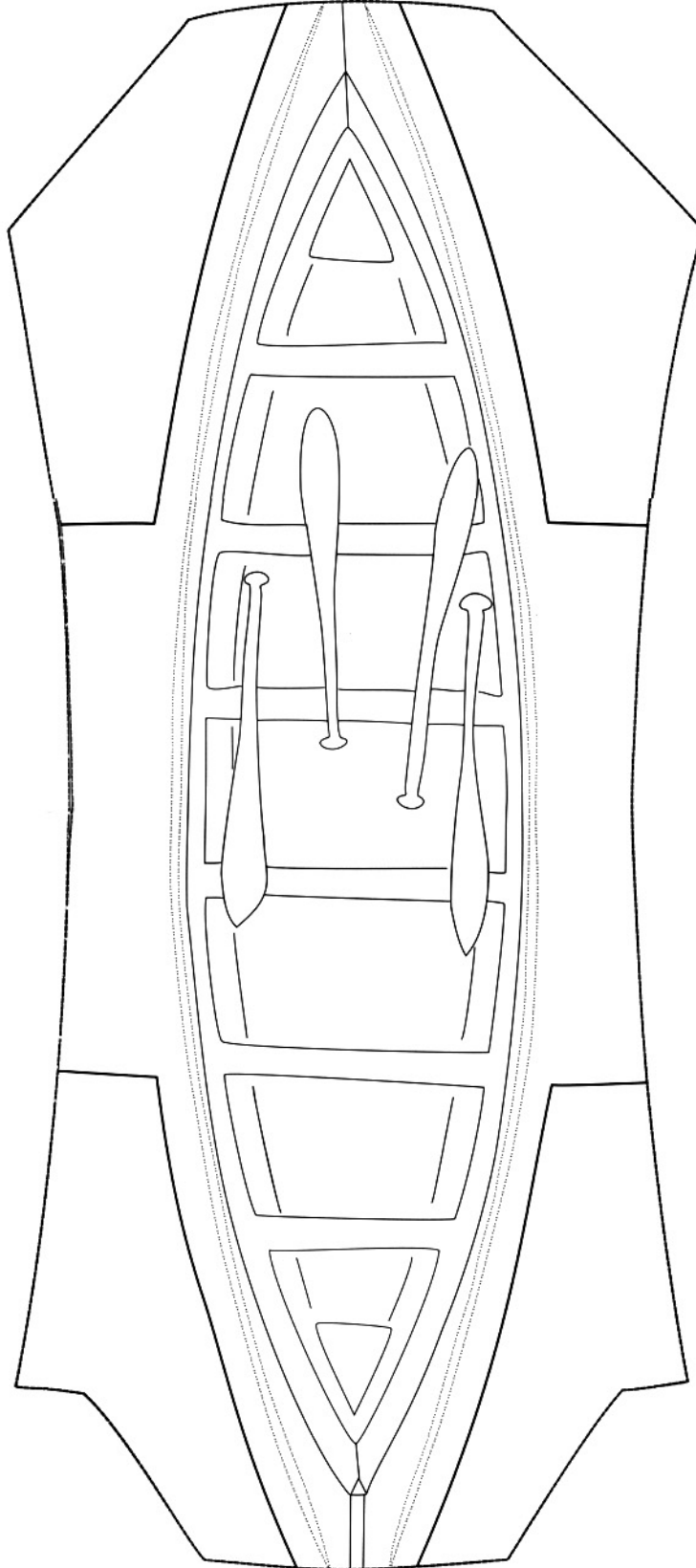

1. Cut out the shape carefully along the outer line.
2. Fold along the double dotted line to form the sides of the canoe.
3. Glue the two sides at one end to make the bow and the other end to make the stern.

# Birchbark Canoe

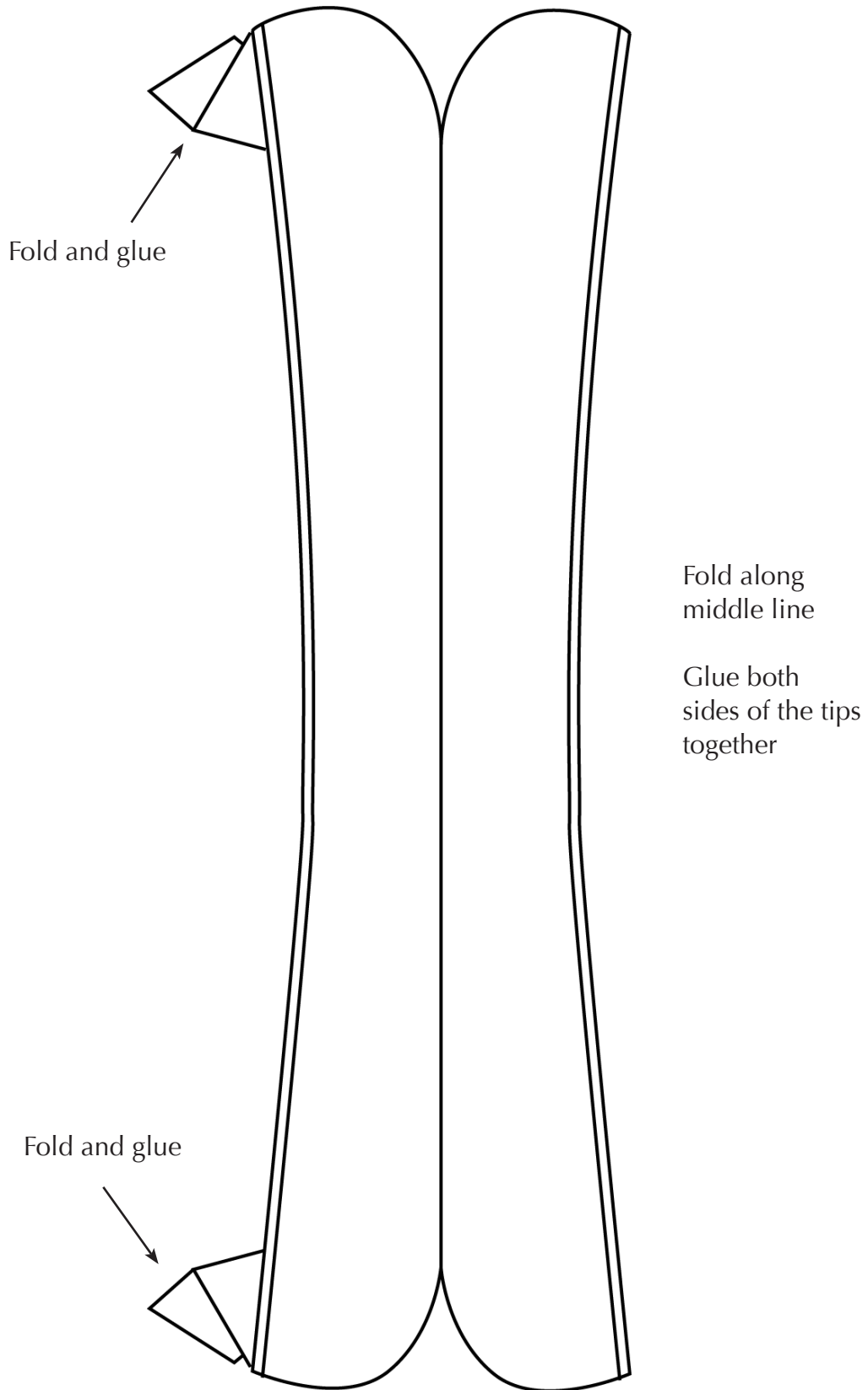

# Kootenai Canoe

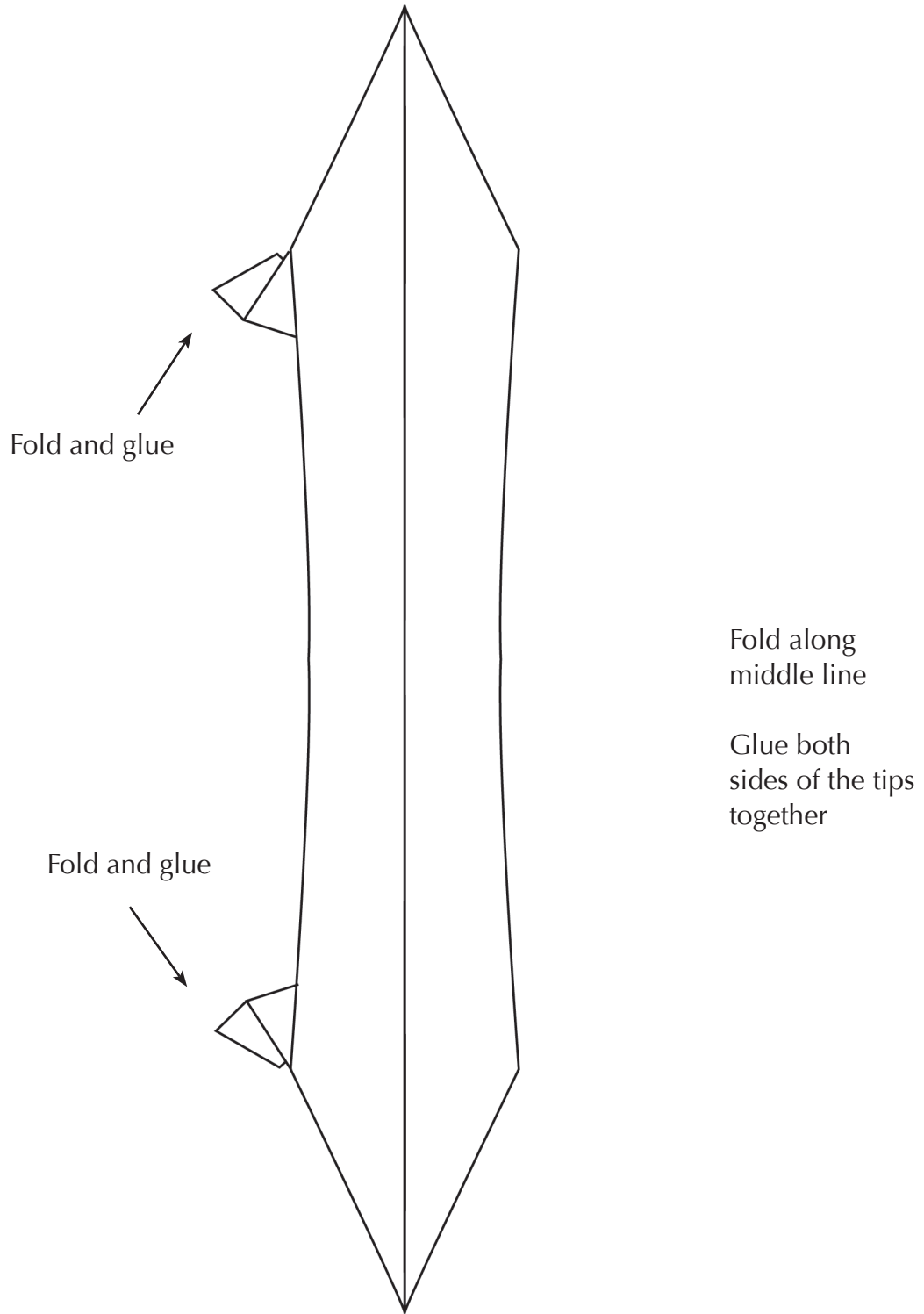



## Traditional Tools

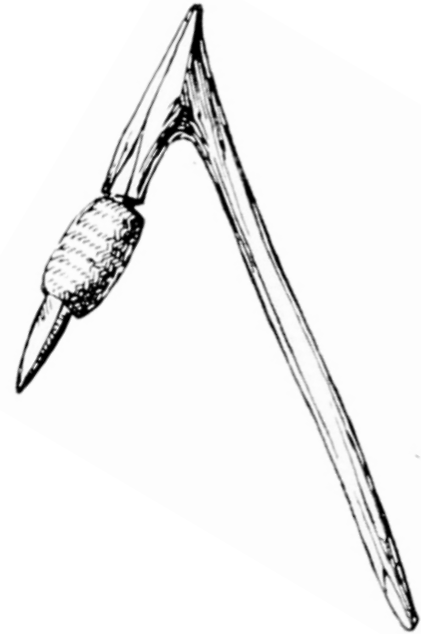
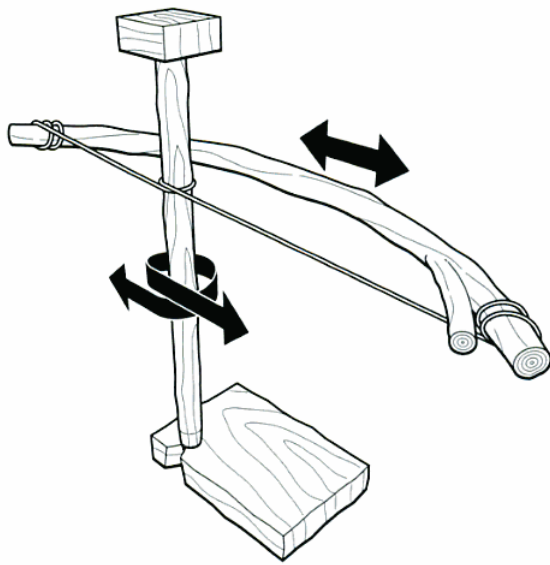

## Scientific Inquiry Using the 7Es

### **Environment**

How does the question connect with the land?

### **Engage**

What do you already know? What do you want to know about the question?

### **Explore**

Find out more details about the question.

### **Elder**

How does the question connect to Traditional Knowledge? Consult an Elder if you can.

### **Explain**

Record your observations and research findings. Plan how you are going to present the answer to your question.

### **Elaborate**

What other questions come out of your research? Complete your project.

### **Evaluation**

How did you do? Were you satisfied with the answer to your question?



# UNIT 4

## BEARS AND BODY SYSTEMS

### Introduction

One of the features of the biodiversity of living organisms is the vast array of body structures, all adapted in one way or another to their environment. This includes internal body systems which work together to enable an organism to survive.

Despite their diversity, all mammals have similar internal body systems. The differences reflect adaptations to their habitat and food sources.

Bears hold a particular interest to many students. Their similarities to humans are often featured in popular culture, while their power and strength are viewed with awe.

At the same time, people have encroached on bears' habitats, creating unfortunate encounters in which the bear usually suffers.

This unit explores both the cultural significance of the bear and the scientific understandings about anatomy and adaptations that can be gained through its study.

### First Peoples Connections

The many different First Nations languages in BC all have a word for “bear,” which speaks to both the presence and cultural significance of this creature throughout our province. Bears that can be found here include the black bear, grizzly bear, and Kermode or Spirit Bear. In the northernmost parts of traditional Inuit territory north of BC, the polar bear can also be found.

The bear is represented in myriad traditional Indigenous stories, dances, and visual representations, including masks, totem poles, crests, and paintings. Though specific beliefs about the bear vary amongst First Nations groups, what is common is how highly revered and respected the bear is.

In many First Nations world views, bears have a spiritual connection with both humans and plants.



## UNIT 4 • BEARS AND BODY SYSTEMS

### PLANNING TO TEACH THE UNIT

This unit fits directly with the Learning Standards of both Science 5 and Science 6, but it can be adapted to all grade levels.

#### Outline of Activities

1. Bears and Culture
2. Bears in Local First Nations Cultures
3. Surviving the Environment
4. Bear Body Systems
5. Comparing Bear and Human Anatomy
6. Comparing Heart Rates
7. Winter Sleep
8. Bears and Ecology



#### Enduring Understandings

- Humans and bears have similar body systems that contribute to their survival, but there are differences in these systems based on adaptations to different environments.
- The Traditional Ecological Knowledge of First Peoples includes a depth of understanding of the biology, behaviour and ecology of bears.

#### Essential Questions

- How do body systems interact and connect with the environment?
- How is traditional knowledge about the biology, behaviour and ecology of bears reflected in First Peoples' lives in the past and the present?



<b>Curriculum Connections</b>	
<b>Suggested Topics and Inquiry Questions</b>	<b>Learning Standards</b> Selected Curricular Competencies and suggested Content Standards. Other Learning Standards may also be applicable.
<b>Science 5</b>	
TEK shows First Peoples’ understandings of structures and functions of the animals in their territories <ul style="list-style-type: none"> <li>• How is First Peoples’ traditional knowledge about the biology of bears demonstrated in the role bears play in First Nations’ cultures?</li> </ul>	<i>Curricular Competencies</i> Identify First Peoples’ perspectives and knowledge as sources of information  Express and reflect on personal, shared, or others’ experiences of place
	<i>Content</i> Basic structures and functions of body systems: digestive, musculo-skeletal, respiratory, circulatory
Interconnectedness of bears in First Peoples’ cultures <ul style="list-style-type: none"> <li>• In what ways can you demonstrate the interconnections between First Peoples, bears and their environment?</li> </ul>	<i>Curricular Competencies</i> Experience and interpret the local environment  Express and reflect on personal, shared, or others’ experiences of place
	<i>Content</i> First Peoples’ concepts of interconnectedness in the environment
First Peoples’ roles in monitoring and protecting bears in their territories <ul style="list-style-type: none"> <li>• How do First Peoples apply traditional knowledge and beliefs to promote the sustainability of bear populations in their territories?</li> </ul>	<i>Curricular Competencies</i> Identify some of the social, ethical, and environmental implications of the findings from their own and others’ investigations
	<i>Content</i> First Peoples’ knowledge of sustainable practices



UNIT 4 • BEARS AND BODY SYSTEMS

Science 6	
TEK shows First Peoples’ understandings of structures and functions of the animals in their territories <ul style="list-style-type: none"> <li>• How is First Peoples’ traditional knowledge about the biology of bears demonstrated in the role bears play in First Nations’ cultures?</li> </ul>	<i>Curricular Competencies</i> Choose appropriate data to collect to answer their questions  Identify First Peoples’ perspectives and knowledge as sources of information
	<i>Content</i> The basic structure and functions of body systems – excretory, reproductive, hormonal, nervous
Bears contribute to a sense of place for First Peoples <ul style="list-style-type: none"> <li>• What features of a bears biology, behaviours and habitats contribute to First Peoples’ sense of place?</li> </ul>	<i>Curricular Competencies</i> Express and reflect on personal, shared, or others’ experiences of place
	<i>Content</i> (no direct link)
Science 7	
First Peoples’ Traditional Knowledge about survival needs of bears <ul style="list-style-type: none"> <li>• How did/do First Peoples use their knowledge of the bears’ survival needs to harvest it sustainably?</li> </ul>	<i>Curricular Competencies</i> Use scientific understandings to identify relationships and draw conclusions  Express and reflect on a variety of experiences and perspectives of place
	<i>Content</i> Survival needs – all organisms need space, food, water and access to resources in order to survive
Local First Peoples’ traditional knowledge of changes in biodiversity <ul style="list-style-type: none"> <li>• How have First Peoples shared their traditional knowledge about bears with scientists to monitor and protect bear species?</li> </ul>	<i>Curricular Competencies</i> Make observations aimed at identifying their own questions about the natural world  Apply First Peoples’ perspectives and knowledge, other ways of knowing, and local knowledge as sources of information
	<i>Content</i> First Peoples’ knowledge of changes in biodiversity over time



Science 8	
First Peoples' understanding of the characteristics of life of bears <ul style="list-style-type: none"> <li>• How do First Peoples' understandings of the characteristics of the life of bears affect the ways they traditionally use and protects bears in their territories?</li> </ul>	<i>Curricular Competencies</i> Use scientific understandings to identify relationships and draw conclusions Transfer and apply learning to new situations
	<i>Content</i> Characteristics of life – living things respire, grow, take in nutrients, produce waste, respond to stimuli, reproduce
Science 9	
Interconnectedness of bears in local ecosystems <ul style="list-style-type: none"> <li>• How can First Peoples' traditional perspectives on interconnectedness and sustainability be applied to the management and protection of bears in British Columbia, particularly with respect to trophy hunting and poaching?</li> </ul>	<i>Curricular Competencies</i> Consider social, ethical, and environmental implications of the findings from their own and others' investigations
	<i>Content</i> First Peoples' knowledge of interconnectedness and sustainability





## UNIT 4 • BEARS AND BODY SYSTEMS

### Suggested Resources

- Online video: *Meet a Local Legend: K'umugwe Dancers*. Aboriginal Tourism BC. 2015. 3:50. <http://bit.ly/2cjDsGt>
- Online video: *Bear Witness*. Central Coast First Nations Bear Working Group. 2013. 22 minutes. On Youtube, <http://bit.ly/2cjDHBm> or the website [www.bearsforever.ca](http://www.bearsforever.ca)
- Traditional narratives about bears
- Blackline Master 4-1, Inside a Bear, page 117
- Blackline Master 4-2, Inside a Human, page 118
- Blackline Master 4-3, Comparing Bear and Human Anatomy, page 119
- Blackline Master 4-4, How Does Your Heart Rate Compare with a Bear? page 120
- *Mammal Anatomy*, by Marshall Cavendish Corporation. This book may be available from your public library or through interlibrary loan
- *Animal Fact File : head-to-tail profiles of more than 90 mammals* by Tony Hare Facts on File, 1999
- Inner Body website: [www.innerbody.com](http://www.innerbody.com)
- Timers or stopwatches

### Suggested Activities

#### 1. BEARS AND CULTURE

As an introduction to this unit, explore various perceptions about bears, including students' personal perspectives, views of bears in diverse First Nations cultures, and perspectives of the government and public in BC.

- a. As preparation for the unit, ask students to collect as many different representations of bears as they can. Ask them to consider the many ways that people think about bears. They may bring in picture clippings, advertising brochures, company logos, cartoons, clothing (e.g. with sports team logo using bears), toys (e.g teddy bears), carvings or other representations. Have some First Nations representations of bears on hand to augment the collection if needed.
  - Have students write a list of words and phrases that come to mind when they think of bears. You may want students to share some of their lists with the whole class.
  - Create a class display of the bear representations. Have students explain orally what some of the representations shows about how people view bears.
  - Discuss what qualities of bears are being highlighted in the different representations. How do they differ? (e.g qualities of a bear in a sports logo and a teddy bear)
  - Discuss with students if there are any similar qualities between humans and bears.



- b. To present an example of the importance of the bear in First Nations cultures, view the video *Meet a Local Legend: K'umugwe Dancers* (<http://bit.ly/2cjDsGt>)
- This 4 minute video shows a 13 year old dancer performing a traditional dance in a bear mask and costume. He discusses his connection with his culture and the land.
  - Ask students to identify features of the bear used in this dance.
  - Discuss the importance of the bear to this boy and his culture.
- c. To understand how First Nations are working with scientists to protect grizzly bears, view the video *Bear Witness*, available on Youtube. (Link at <http://bit.ly/2cjDHBm> or search keywords Bear Witness First Nations).
- This 22 minute video takes a compelling look at the issue of trophy hunting of grizzly bears on BC's Central Coast, while illustrating the relationships of people and bears and the connections First Nations have with the bears and the land. It also shows a strong relationship between First Nations guardians and scientists who share research into bear populations. It focuses on the trophy hunting of a bear which had been named "Cheeky."
  - NOTE: This video includes a number of short but graphic clips of dead bears and bear parts.
    - Make sure you preview it to make sure it is appropriate for your students.
    - When viewing it, prepare students for what they are about to see.
    - For younger students you may decide to only show sections of the video.
  - This video has a number of themes which can be discussed and expanded upon:
    - The spiritual connections First Nations have with the grizzly bear
    - Sports hunting, government laws and public perception
    - Collaboration between First Nations and scientists
    - Using DNA to study bear populations
    - The similarities between bear and human body structures
  - Ask students to record a journal response to this video.
  - On August 24 2016, people from the Heiltsuk, Nuxalk, Kitasoo/Xai'xais, and Wuikinuxv First Nations rematriated the skull, hide and paws which had been taken as trophies. A ceremony was held in Kwatna Inlet, where the bear lived and died.
    - Students can search the web to find articles about this event. See for example the article at the link <http://bit.ly/2dD4qfo>.
    - Ask students to reflect on why this was an important ceremony for the First Peoples to hold.

## 2. BEARS IN LOCAL FIRST NATIONS CULTURES

What are the local First Peoples teachings or cultural significance of bears in your area? (stories, art, research, local knowledge keepers, etc.) Ask students to



## UNIT 4 • BEARS AND BODY SYSTEMS

investigate the importance of bears to local First Nations cultures. This could include traditional stories and teachings about bears in your area, bears in ceremonies such as dances, and traditional uses of bears as resources. Many First Nations groups have a clan or other important group named after a bear.

- a. Invite a local First Nations Elder or knowledge keeper to speak to the class about bears in your community. This could include:
  - culture importance
  - a traditional story that features a bear
  - personal experiences with bears
  - local teachings about staying safe when out in the environment where bears live
  - hunting of bears
  - scientific studies
- b. Invite a language teacher or other speaker to teach students words related to bears in the local First Nations language, such as names for different bear species, and parts of bears, such as claws. Are there unique names for the bear's internal organs?
- c. Are there any other traditional stories about bears from the First Nations groups(s) in your area? Find a traditional First Nations story that features a bear, preferably one that is local to the First Peoples in your area. Some suggested resources are listed in Additional Resources below.
  - The story “Coyote wins daylight” can be found in *First Nations in BC: Comparing Interior and Coastal Cultures* by Karin Clark (p35-36). Grizzly Bear wants darkness during the winter; Coyote wants daylight.

### 3. SURVIVING THE ENVIRONMENT

Have students investigate how bears and humans are able to survive in the environments they live in.

- a. Ask students to describe the environments where bears and humans live.
  - What are the challenges in the way of survival for each species?
  - What are the similarities and differences?
- b. Ask students to use their knowledge to predict how people and bears are adapted to surviving in their environments.
  - Brainstorm ways that bears are adapted to their environment.
  - Brainstorm ways that humans are adapted to survive in their environment.
- c. List some of the similarities and differences between how humans and bears are adapted for survival.



#### 4. BEAR BODY SYSTEMS

Have students research the basic structures and systems of selected body systems in bears. Investigate how these systems contribute to survival.

- Grade 5. The body systems addressed in the BC Science 5 curriculum are
    - digestive
    - excretory (digestive and urinary)
    - respiratory
    - circulatory
  - Grade 6. The body systems addressed in the BC Science 6 curriculum are
    - musculoskeletal (skeletal and muscular)
    - reproductive
    - hormonal (endocrine)
    - nervous
- a. Have students work in groups to research one of the body systems in bears. Provide library books and online access for students to do their research.
- A comprehensive book that describes and illustrates all the body systems of the grizzly bear (except for hormonal) is *Mammal Anatomy*, by Marshall Cavendish Corporation. If your school library does not have it, it may be available from your public library or through interlibrary loan.
  - The book *Animal Fact File* shows the skeletal system of both the black bear and the grizzly bear, giving opportunities to compare the two.
  - This activity can be adapted for some learners, or altered if sufficient reference materials are not available for the body systems, by researching the external features of bears that show adaptations for survival, such as fur, claws, teeth, and head shape.
- b. Students should identify the anatomical structures of the body system they are studying, and their functions. Ideally they will be able to draw or make a copy of an illustration and label the features.
- You may want to use the bear template on Blackline Master 4-1.

#### 5. COMPARING BEAR AND HUMAN ANATOMY

Have students compare human and bear body systems.

- a. Provide research materials such as library books on human anatomy, or the web sites such as Inner Body ([www.innerbody.com](http://www.innerbody.com))
- Inner Body is an interactive site that gives details drawings of all body systems of humans.
- b. You may want to have students use the human template on Blackline Master 4-2 to draw one or more of the body systems.
- c. Use Blackline Master 4-3, Comparing Bear and Human Anatomy, to study the similarities and differences in the bear and human leg.



## UNIT 4 • BEARS AND BODY SYSTEMS

### 6. *COMPARING HEART RATES*

Have students compare their heart rate with that of bears and other mammals.

- a. Have students work in pairs to observe their resting heart rate. Use Blackline Master 4-4 which includes instructions and questions.
- b. Ask students to use data about the resting heart rate of selected mammals to develop a hypothesis about factors affecting the heart rate (and thereby the circulatory system) of mammals. (See Blackline Master 4-4.)

### 7. *WINTER SLEEP*

Ask students to investigate the question, What happens to a bear's body systems when it goes into its winter sleep?

- a. Have students to work in groups to find out what happens to bear when they hibernate or go into their winter sleeps, focussing on changes to different body systems.
  - Which body systems change? Which do not change?
- b. Have students present their findings in an interesting format, such as a poster or power point.
- c. You may want students to consider the question, Do bears really hibernate? Some scientists say bears' winter denning behaviour is not true hibernation, and call it winter sleep. Others call it a special type of hibernation.
  - Students could debate the topic, or present their conclusions to the class giving supporting evidence.

### 8. *BEARS AND ECOLOGY*

Investigate studies and issues concerning bears in the local region and BC-wide.

- a. Have students find out if there is any research that is being conducted about bears in your area.
- b. Students may conduct an inquiry into any environmental issues that are affecting bears in your area, such as hunting and poaching, habitat loss, climate change, salmon stocks.
- c. Students may be interested to compare how bears that live in different areas are uniquely adapted to their environments? (eg. Polar bears, panda bears, bears in a zoo.)



## Assessment

Here are some suggestions for assessing the Essential Questions of the unit. See general suggestions for assessment in the Introduction, page 24.

1. How do body systems interact and connect with the environment?
  - a. Ask students to create a visual (a poster, a digital presentation, a drawing, etc.) that compares the location and functions of the relevant body systems in humans and bears.
    - They should summarize how these systems are unique in humans and bears and explain how these differences are connected to survival in their environments.
    - Explain how these body systems interact for survival.
- 2 How is traditional knowledge about the biology, behaviour and ecology of bears reflected in First Peoples lives in the past and the present?
  - a. Ask students to predict how First Peoples' traditional knowledge of the bears' biology helps then understand how to successfully hunt bears.
  - b. Ask students to create a graphic organizer that demonstrates the interconnectedness of bears in First Peoples' cultures.

## Suggested Resources

*Bear Witness*. Central Coast First Nations Bear Working Group. 2013. 22 minutes. On Youtube, link at <http://bit.ly/2cjDHBm> or the website [www.bearsforever.ca](http://www.bearsforever.ca)

Clark, Karin. *First Nations in B.C.: Comparing Interior and Coastal Cultures*. Fifth edition. First Nations Education Division, Greater Victoria School District. 2002. Teachers' resource guide with many activities for comparing interior and coastal First Nations. Specific topics on comparing environments, housing, transportation and clothing. It includes a story featuring the Grizzly Bear, "Coyote Wins Daylight" p. 35-36.

Hare, Tony. *Animal Fact File : head-to-tail profiles of more than 90 mammals*. Facts on File, 1999.

This work covers 90 warm-blooded animals from around the world, each animal on a two-page, full-colour illustrated spread that shows the entire mammal and highlights interesting parts of its anatomy. Good source for bear anatomy if available.

Inner Body website. [www.innerbody.com](http://www.innerbody.com)

Students have the opportunity to interactively investigate the human anatomy.



## UNIT 4 • BEARS AND BODY SYSTEMS

*Kou-Skelowh – We Are The People: A Trilogy of Okanagan Legends.* Theytus, 1999.  
Contains three Okanagan traditional narratives including How Food was Given. Led by Grizzly Bear, the plants and animals promise to sacrifice themselves to provide food for humans.

McAllister, Ian and Nicholas Read. *The Salmon Bears: Giants of the Great Bear Rainforest.* Orca, 2010.

Explores the delicate balance that exists between the grizzly, black and spirit bears that inhabit the last great wilderness along the central coast of British Columbia and their natural environment.

*Mammal Anatomy*, by Marshall Cavendish Corporation.

*Meet a Local Legend: K'umugwe Dancers.* Aboriginal Tourism BC. 2015. 3:50.  
<http://bit.ly/2cjDsGt>

A 13 year old dancers shows his connection with his culture and the land, and performs a traditional dance in a bear costume. “I’m wearing a mask that is from a tree that is from 100s of years ago. The fire is our connection with our ancestors.”

*The Salmon Bears Learning Guide.* Download at  
<http://orcabook.com/greatbearbooks/teachers.html>.

A series of activities to use with the book *The Salmon Bears* in Life Science, Earth and Space Science and English Language Arts.

Sechelt Nation. *Mayuk the Grizzly Bear.* Gibsons, Nightwood Editions. 1993.

A Sechelt Elder tells a traditional narrative when he gives a name to his great grandson. Two brothers rescue their younger brother from a grizzly bear that they wounded when they were hunting. The baby is not named after the brave hunters, but after the respected foe, Mayuk the grizzly. Contains elements of TEK, such as knowledge of bears’ anatomy and use of medicinal plant.

Vernon, Caitlyn. *Nowhere Else on Earth: Standing Tall for the Great Bear Rainforest.* Orca, 2011.

Filled with history, biology, geography, ecology, environmental studies, personal anecdotes, pictures, and activities about the Great Bear Rainforest.



# Inside a Bear

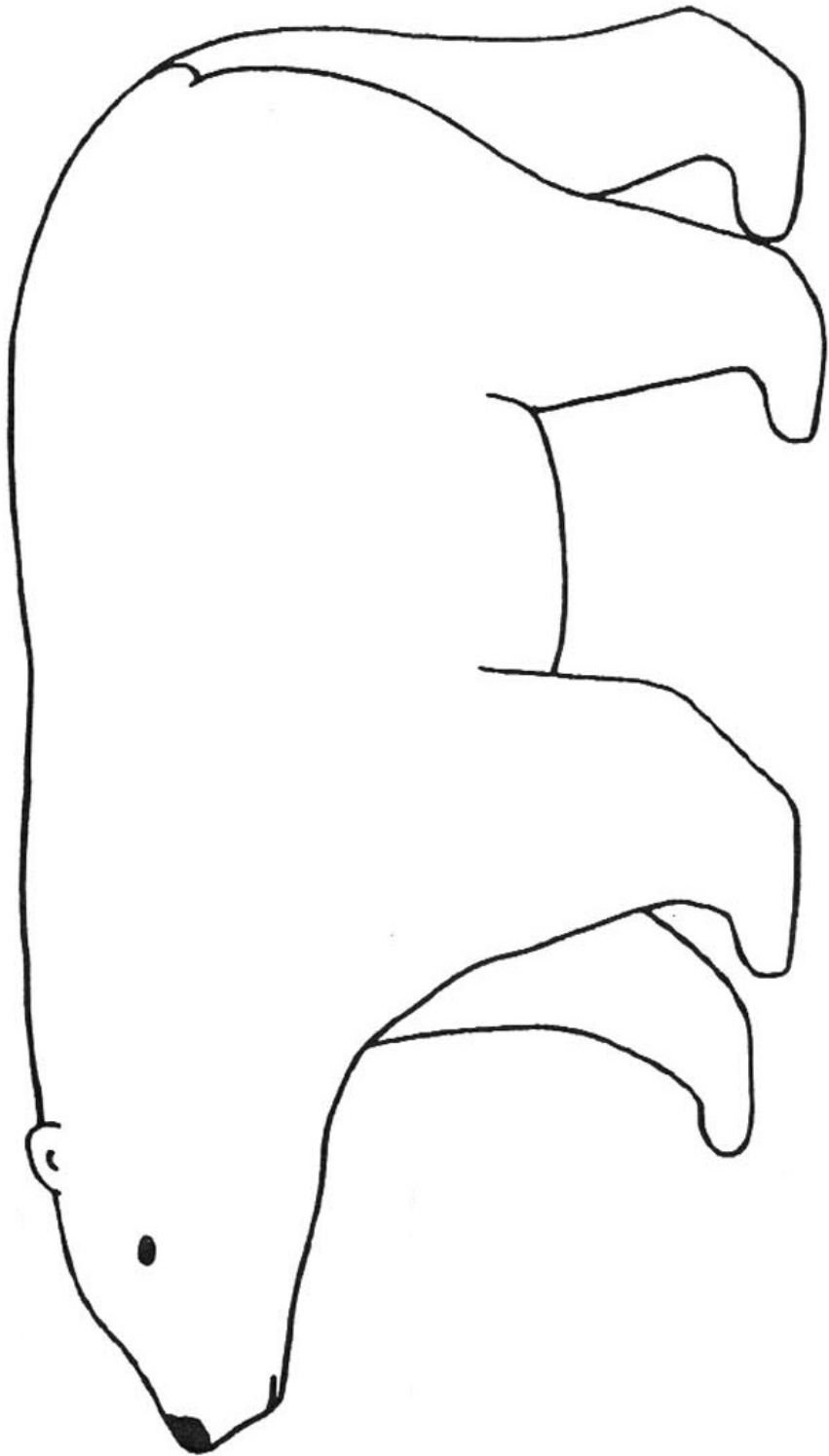

## Inside a Human

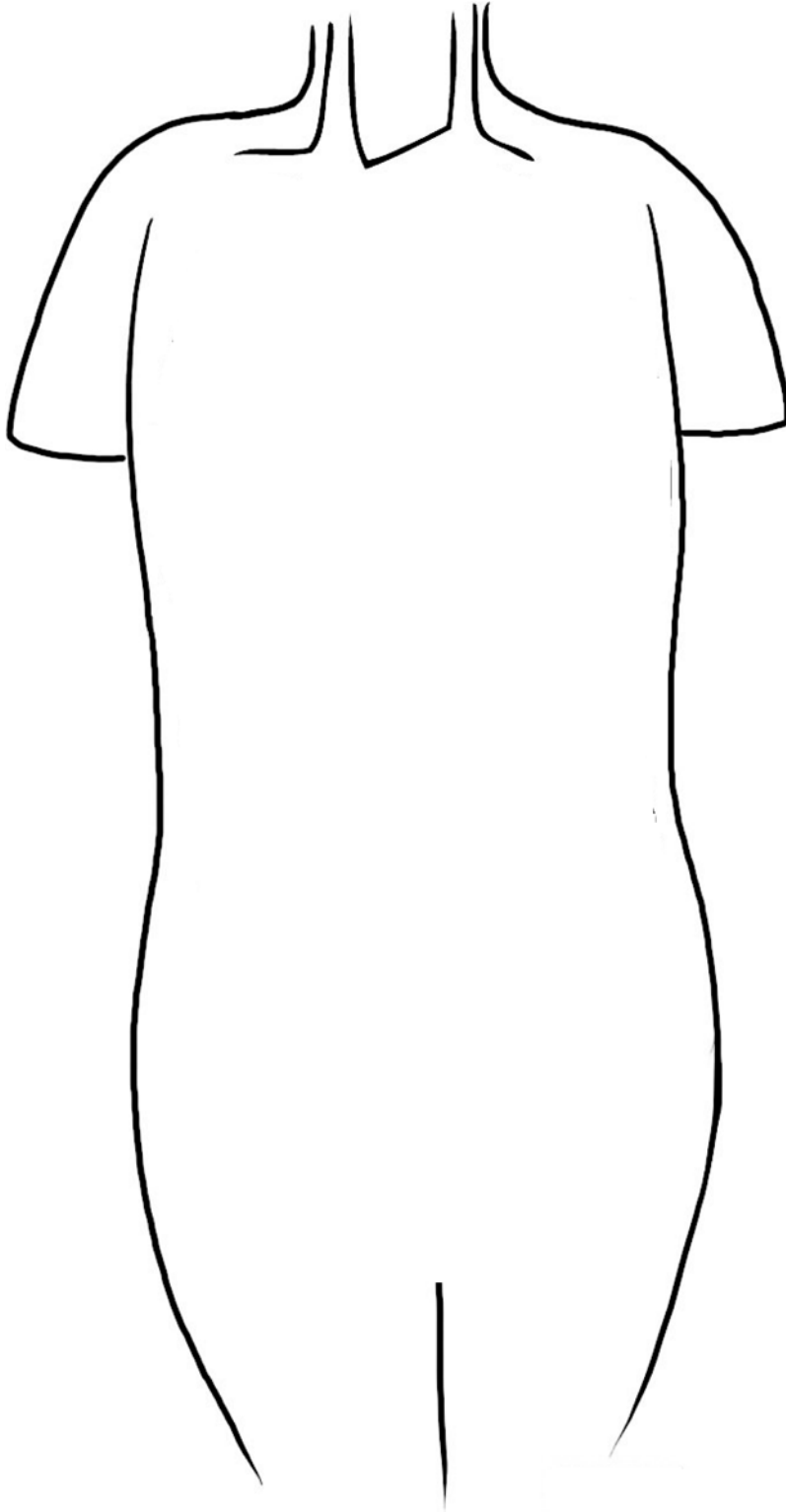

## Comparing Bear and Human Anatomy

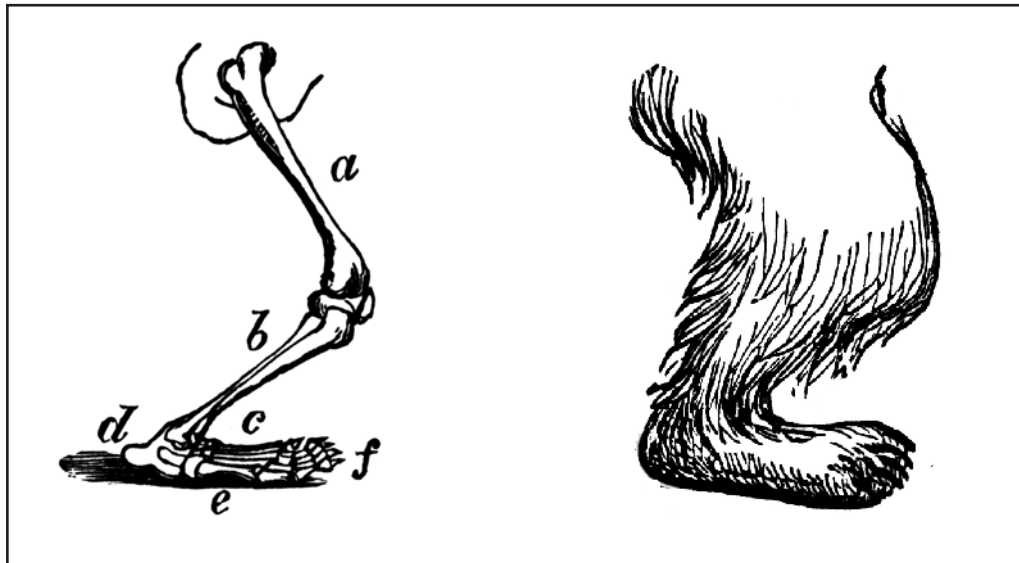

The anatomy of a bear's leg.  
a. femur (thigh) b. tibia (leg) c. tarsus and metatarsus (foot)  
d. calx (heel) e. planta (sole) f. digits (toes)

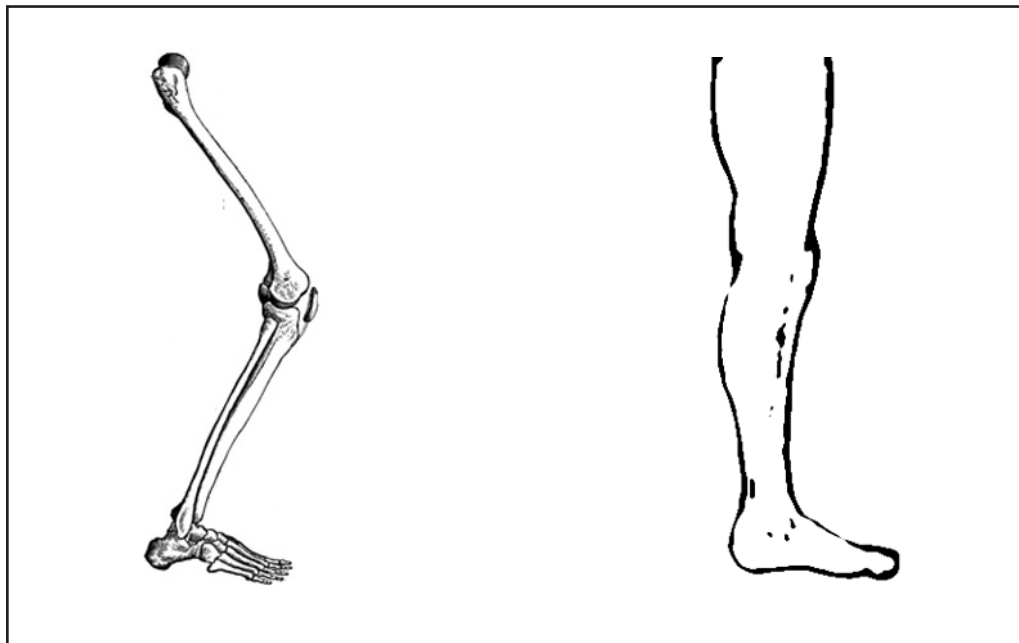

The anatomy of a human leg.  
Label the bones of the human leg.  
Compare the skeletal views and the external views of the bear and human legs.

## How Does Your Heart Rate Compare with a Bear?

Materials: clock, watch or timer

Work with you partner to determine your resting heart rate.



1. Predict what your heart rate will be. How many times a minute does your heart pump blood through your circulatory system?
2. Measure each other's pulse.
  - One person rests their arm on the desk, with their elbow bent.
  - The other person puts their middle and index finger on the artery on the inside of the first person's wrist. They should feel the pulse beating.
  - Count the number of heart beats for 30 seconds.
3. Calculate your heart rate over 1 minute.
  - Multiply your count number by 2.
  - Add your heart rate to the chart below, Comparing Mammal Heart Rates.
4. Do a minute of physical activity, then find your active heart rate.

My predicted resting heart rate  
(beats per minute)

My resting heart rate (bpm)

My active heart rate (bpm)

Think about how your heart rate compares with bears and other mammals.

1. Why do you think your heart rate was different from the black bear?
2. Study the chart Comparing Mammal Heart Rates. What do you think is one of the main factors that affects the resting heart rate of a mammal?
3. What other factors might affect the resting heart rate?
4. Write a hypothesis about the resting heart rate of mammals.
5. How could you test your hypothesis?

### Comparing Mammal Heart Rates

<u>Mammal</u>	<u>Resting heart rate (bpm)</u>
Horse	38
Black bear	45
Moose	70
Dog, large	85
Human youth	_____
Beaver	100
Cat	150
Rabbit	205
Mouse	670



# UNIT 5

## PERSPECTIVES ON CLIMATE CHANGE

### Introduction

In this unit students will investigate First Peoples' perspectives on one of the world's most serious issues, climate change.

With discussions of climate change appearing in the news daily, it is a topic that almost everyone, from scientists and economists to politicians and the general public are aware of. Dealing with it will be a major concern for students in their future adulthood.

The earth and its climate has always changed over time, but since the Industrial Revolution the impact of humans has had a major impact on this change.

The impact of global climate change is estimated to have the greatest effects in far northern ecosystems. However, British Columbia is anticipated to experience increased climate variability in the temperate-to-northern coastline and regions

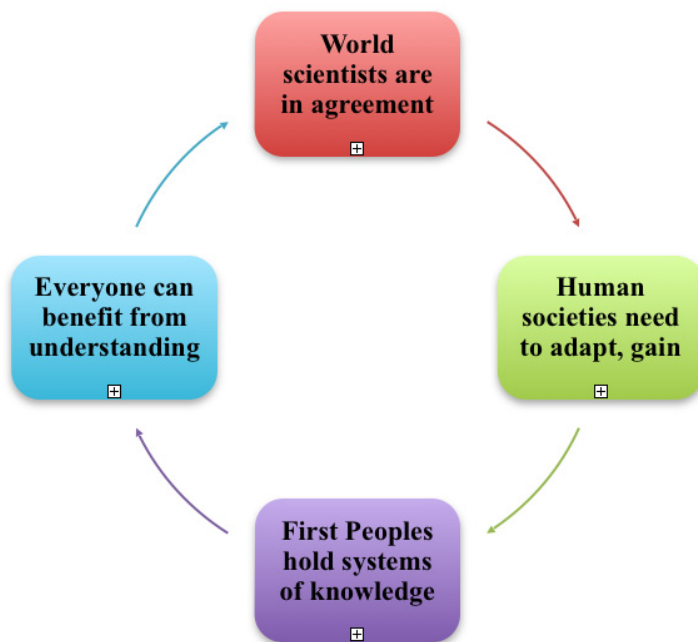

Partnerships in Climate Action



## UNIT 5 • CLIMATE CHANGE

of mountainous terrain. First Peoples of BC have a deep traditional ecological knowledge (TEK) of these regions through countless generations of seasonal food gathering, adaptations to the landscape and environments in their traditional territories.

Students will investigate these changes, using traditional knowledge and current events as some of their sources. A specific study will investigate lessons from communities that have lived sustainability for countless generations through the lens of salmon.

Finally students will inquire into the necessary skills for adapting to and reducing climate changes with resiliency, taking lessons from First Peoples who have faced vast environmental and social changes with the strength and persistence needed for survival.



## First Peoples Connections

The First Peoples of BC have always experienced and learned to respond to environmental change. The oral histories passed down for countless generations speak of the responses to such change, especially since the coming of Europeans.

The diverse nations of First Peoples in this province lived closely with the land, through seasonal food gathering and careful observations of the health of the plant and animal species and weather patterns. Central to this relationship has been respect and reverence for the generosity of the land and repercussions of unsustainable harvesting practices.

There are over 30 distinct Indigenous language groups in BC alone. Embedded in these languages and oral histories is the knowledge of unique technologies and systems for living successfully in these territories. Since contact in the 1700's, First Peoples have experienced significant impacts on aspects of the transmission of this traditional knowledge, changes in land-based practices, changing economies, and imposed political structures.

In recent times there has been significant improvements in culture and language revitalization, reclaiming of Indigenous rights, and recognition of the legacy of residential schools through the Truth and Reconciliation Commission report. First Peoples in BC retain strong and persistent relationships to the land.

The First Peoples of BC continue to closely observe and monitor seasonal changes, climate, and abundance of numerous plant and animal species. Along the coast it is especially important to have reliable information of weather patterns, ocean currents and tides to safely conduct season food gathering.

Recently the seasonal indicators that TEK depends on have become less predictable and reliable. Climate variability and impacts of environmental changes has caused considerable concern for the Nations in BC.

At present, there have been increased observations of environmental change which is concerning to First Peoples who rely on their resilient relationship with the land. These observations and perspectives are important to include in discussions and considerations of global climate change.

Many traditional territories in BC are sites amongst the longest continuous human habitation in the world. This was accomplished through knowledge of sustainable practices and adaptive technologies.



## UNIT 5 • CLIMATE CHANGE

### PLANNING TO TEACH THE UNIT

This unit is in three parts. The first gives an introduction to climate change; the second focusses on how climate change affects the salmon resource; the third gives suggestions for an inquiry into resiliency and climate change.

#### Outline of Activities:

##### *PART ONE: EARTH AND IT'S CLIMATE CHANGES OVER TIME*

1. Climate Change As A Current Event Story – Engaging Learners
2. How Has the Earth and Its Climate Changed?
3. Oral Histories Of Climate Changes Over Time

##### *PART TWO: RESPECT FOR THE LAND – SALMON AND CLIMATE CHANGE*

1. Salmon in Hay River?
2. Salmon on the Local Scene
3. Evidence of Climate Change
4. Impacts on Salmon Habitat
5. Simulating the Effects of Climate Change Through Water Sources
6. Water Quality Activity

##### *PART THREE: RESILIENCY DURING CHANGE*

1. Problem-Based Learning: A Look At The Local Effects Of Climate Change
2. Lessons in Resiliency: First Climatologists

#### Enduring Understandings

First People hold a wealth of knowledge about ways to adapt to the changes in the natural world, including changes brought about by climate change.

In the past people could rely on their traditional knowledge to predict natural indicators, such as where and when they could harvest resources, but now these indicators are much less predictable.

#### Essential Questions

How can Traditional Ecological Knowledge help scientists study climate change?

What can we learn from Indigenous peoples to help us live sustainably in the face of climate change?





Curriculum Connections	
Suggested Topics and Inquiry Questions	Learning Standards
Science 5	
Interconnectedness of First Peoples and their environment <ul style="list-style-type: none"> <li>• What signs have First Peoples observed that provide evidence of the effects of climate change?</li> </ul>	<i>Curricular Competencies</i> Experience and interpret the local environment  Express and reflect on personal, shared, or others' experiences of place
	<i>Content</i> First Peoples' concepts of interconnectedness in the environment
First Peoples' knowledge of sustainable practices <ul style="list-style-type: none"> <li>• How can we apply First Peoples' understandings of sustainability to reduce the effects of climate change?</li> </ul>	<i>Curricular Competencies</i> Identify some of the social, ethical, and environmental implications of the findings from their own and others' investigations
	<i>Content</i> First Peoples' knowledge of sustainable practices
Science 6	
Climate change and the effects on First Peoples' sense of place <ul style="list-style-type: none"> <li>• What evidence is there of environmental changes such as climate change contained in First Peoples' traditional narrative and stories?</li> <li>• What impacts could climate change have on First Peoples' sense of place in the future?</li> </ul>	<i>Curricular Competencies</i> Express and reflect on personal, shared or others' experience of place
	<i>Content</i> (no direct link)



UNIT 5 • CLIMATE CHANGE

Science 7	
<p>First Peoples' traditional knowledge can help to identify changes in the environment due to climate change</p> <ul style="list-style-type: none"> <li>• How can Traditional Ecological Knowledge help scientists study climate change?</li> <li>• How can we apply First Peoples' understandings of sustainability to reduce the effects of climate change?</li> </ul>	<p><i>Curricular Competencies</i> Make observations aimed at identifying their own questions about the natural world</p> <p>Identify First Peoples' perspectives and knowledge as sources of information</p>
	<p><i>Content</i> Local First Peoples' knowledge of climate change</p>
Science 8	
<p>First Peoples' traditional knowledge about the characteristics of life of plants and animals in their territories</p> <ul style="list-style-type: none"> <li>• How is First Peoples' knowledge about the characteristics of life of plants and animals used to help scientists understand the effects of climate change?</li> </ul>	<p><i>Curricular Competencies</i> Apply First Peoples' perspectives and knowledge, other ways of knowing, and local knowledge as sources of information</p> <p>Express and reflect on a variety of experiences and perspectives of place</p>
	<p><i>Content</i> Characteristics of life: living things respire, grow, take in nutrients, produce waste, respond to stimuli and reproduce</p>
Science 9	
<p>Local First Peoples' traditional knowledge of changes in local ecosystems due to climate change</p> <ul style="list-style-type: none"> <li>• In what ways have First Peoples' observations shown changes in the interconnectedness of different spheres due to climate change, such as water and land, fish and water</li> <li>• How have First Peoples' observations about changes in local ecosystems helped scientists monitor the changes brought about by climate change?</li> </ul>	<p><i>Curricular Competencies</i> Make observations aimed at identifying their own questions about the natural world</p> <p>Apply First Peoples' perspectives and knowledge, other ways of knowing, and local knowledge as sources of information</p>
	<p><i>Content</i> First Peoples' knowledge of interconnectedness and sustainability</p>



**PART I**  
**EARTH AND ITS CLIMATE CHANGES OVER TIME**

**Question for Inquiry**

What are the evidences of climate change over geologic time and how has human behaviour enhanced these changes?

**Suggested Resources**

Blackline Master 1, Climate Change in the News, page 137

Blackline Master 2, Evidence from Oral Histories, page 138

Climate Change 101 with Bill Nye the Science Guy, Youtube video. Link at <http://bit.ly/1Za2D3f>

**Suggested Activities**

*1. CLIMATE CHANGE AS A CURRENT EVENT STORY – ENGAGING LEARNERS*

Climate change is a widely discussed topic that most students will be aware of. Assess what students already know about it, and investigate the latest issues in the news.

- a. Generate a class-wide brainstorm on what students have already heard or read about climate change. Discuss what are the most important concerns they have.
- b. Changes to the earth's climate are felt throughout BC.
  - Ask students if they have heard of family or community members who have noticed unusual changes in the environment that may be caused by climate change.
- c. In pairs, provide students with current news articles on climate change from various viewpoints – some local, regional, national and international. Be sure to include First Peoples perspectives such as the article on Blackline Master 5-1.
  - Ask students to highlight two or three concerns from the article that can be added to the class brainstorm. This provides students with an inquiry mindset and questions to begin the unit of study.

*2. HOW HAS THE EARTH AND ITS CLIMATE CHANGED?*

Depending on the ages and experience of your students, teach or review some of the key concepts of climate change.

- a. Show a video, such as Climate Change 101 with Bill Nye the Science Guy, <http://bit.ly/1Za2D3f>



## UNIT 5 • CLIMATE CHANGE

- b. Use these question for discussion:
- What is the difference between global warming and climate change?
  - What are fossil fuels and how do they cause climate change?
  - Is climate change something that will happen far in the future or are we seeing it now? Explain your reasoning.
  - Name some examples of changes in climate or extreme weather. What are some recent extreme weather events that have happened around the world?
- c. Here are some key terms for students to understand:
- Global warming: the heating up of the Earth caused primarily by the burning of fossil fuels (oil, coal and natural gas), which releases heat-trapping carbon dioxide into the atmosphere.
  - Climate change: the altering of climate patterns (e.g. more precipitation, more intense storms, floods or droughts) on Earth caused by the burning of fossil fuels.
  - Carbon dioxide (CO<sub>2</sub>): a heat-trapping molecule, and the principal greenhouse gas of concern to climate scientists. A growing concentration of CO<sub>2</sub> from burning fossil fuels is warming the Earth.
  - 2°C: the amount of global warming above pre-industrial levels (200 years ago), which could lead to catastrophic outcomes for human populations (and countless other animal and plant species). The Earth has already warmed by 0.8°C above pre-industrial levels.

### 3. ORAL HISTORIES OF CLIMATE CHANGES OVER TIME

First Peoples of BC have passed down oral histories for countless generations that tell of changes to the climate, sea level and landscape. This history has been upheld in the Supreme Court as reliable and accurate accounts as well as being supported by geological and archeological evidence. Locate oral histories for your region that are permitted for sharing or invite a role model, knowledge keeper or storyteller in to share.

- You may want to use Blackline Master 5-1, Evidence from Oral Histories, as a template for students to record their findings.



**PART 2**  
**RESPECT FOR THE LAND –**  
**SALMON AND CLIMATE CHANGE**

**Question for Inquiry**

How has salmon, a critical species for most BC First Nations, been impacted by climate change?

**Suggested Resources**

- Blackline Master 5-3, Salmon in Hay River?, page 139
- *River of Salmon Peoples*, Theytus Books, 2015

**Suggested Activities**

*1. SALMON IN HAY RIVER?*

Introduce the unit with the recent headline story about a man who caught a chum salmon in Hay River, NWT: “Salmon in Hay River? Local Fisherman’s Catch Shocks Residents.” See Blackline Master 5-3.

- Discuss why the community would be so shocked.
  - Ensure students understand it is a Pacific salmon far out of its normal range.
- Locate Hay River on a map. How far away from home was the fish? (Assuming it was a BC fish, though it was probably an Alaskan fish.) What route did it probably take to get there?
- Ask students to predict how the Pacific salmon might have ended up in Great Slave Lake.
- Use the news article about the discovery by reading it aloud, or making copies for students to read.
  - Ask students to write two facts and two questions about climate change that this article makes them think of.
- Discuss with students why they think more and more salmon are heading for the Arctic Ocean rather than the Pacific?

*2. SALMON ON THE LOCAL SCENE*

Explore with the class how and why salmon are important to First Nations in your community and in most of BC.

- Ask students to brainstorm their ideas about why the salmon is important. Make a class list and ask students to rank the ideas from most important to least important.



## UNIT 5 • CLIMATE CHANGE

- b. Engage students in one or more activities that expand on the importance of salmon. Some possible activities are:
- Invite an Elder or knowledgeable community member to the class to speak about the importance of salmon culturally and economically. This could also be tied in with Activity 3 by asking if they have noticed changes to salmon in recent years.
  - If available, visit a local stream or river during spawning time, or a salmon hatchery.
  - Read a traditional salmon story local to your region. See suggestions in Additional resources listed below.
  - View a video about the importance of salmon. See suggestions in Additional Resources listed below.
  - Research the topic using published and online materials.
- c. Ask students to review their lists and priorities. Would they change anything?
- d. Ask students to discuss what impact there would be if large populations of salmon decided to head for the Arctic (assuming climate change continues to create accessible ecosystems for salmon there).

### 3. EVIDENCE OF CLIMATE CHANGE

Ask students to investigate the question “What can the Elders and other community members tell us about climate change in the local ecosystem?”

- a. Introduce or review the term Traditional Ecological Knowledge.
- Give some examples, and ask students if they know of any examples from people in their community. (See Unit 1 for more ideas.)
- b. Explore historical knowledge learned from the study of traditional narratives that may have been recorded by people in your region.
- If none are available you may want to use some from another BC community.
- c. Ask Elders and other knowledgeable community members to share their observations about the local environment that may be caused by climate change.
- You may want to have one or a small group of speakers come to the classroom, or meet at a community centre with the students.
  - Or you may want to have students work in groups to interview an Elder or other community member, and report back to the whole class.
  - Work with students to develop questions to ask the speakers or interviewees.
  - If you are unable to arrange speakers or interviews, you may want to use some published interviews with elders. See, for example, *Forests and Oceans for the Future*, Unit 7 (<http://www.ecoknow.ca/documents/tekUnit7.pdf>)
  - Another source is the book *River of Salmon Peoples*. It includes many useful discussions and memories about salmon and the Fraser River, and how the salmon resources has changed over time. Some examples are:



- page 62, Nle'kepmxcin
  - pages 66-67, Dakelh and Tsilhqot'in
  - page 105, Nle'kepmxcin
  - For more suggestions, see the activity Strangers in a Strange Land on the Canadian Wildlife Federation website. (Link at <http://bit.ly/2d3RBw7>)
- d. As a class, construct a chart showing some of the evidence for climate change.
- Further the discussion and ask the students to problem solve with possible solutions for changing climates.

#### 4. IMPACTS ON SALMON HABITAT

Speak about salmon's unique habitat, both fresh and salt water.

- a. Ask students to reflect on how climate change impacts the salmon's habitat, such as water temperature, water quantity and food sources such as aquatic invertebrates.
- b. Speak about how this might impact aquatic invertebrates/salmon/fish/water temperatures (water quality) and water quantity. Create an understanding of how salmon might also be impacted by changing climates

#### 5. SIMULATING THE EFFECTS OF CLIMATE CHANGE THROUGH WATER SOURCES.

Challenge students to adapt a salmon migration obstacle course to include the factors of warmer water and lower water levels. They can prepare it for the younger students in your school – or in connection with a primary school.

- a. Give students an opportunity to become familiar with the standard salmon migration obstacle course.
  - Use suggestions from the Telus Science World website. Link at <http://bit.ly/2d6Ney0>.
- b. Once they understand the purpose and steps of the original game, ask students how they could introduce the further challenges of poor water quality and low water levels.
- c. Challenge students to test the new design, and try it out with a younger group.
- d. Assess the project by evaluating how well students incorporated the factors of increased water temperature and lower water levels.



## UNIT 5 • CLIMATE CHANGE

### 6. WATER QUALITY ACTIVITY

Have students investigate the quality of a local fresh water source by conducting a field or lab activity.

- a. A possible activity is for students to collect live macro invertebrates from a river or stream and classify and count them.
  - The resulting data can be used in the same way scientists do to get an indication of the quality of the water.
  - A good source for this activity can be found at this link: <http://bit.ly/2dA19gZ/>
- b. Extend this further by developing questions around the quality of water that you were able to sample.
  - Ask how the healthy (or unhealthy) water might be impacted by climate change.
- c. If you are able to retrieve or access data publicly on the changes in the particular stream you are sampling, comparative studies can be established.
- d. Ask questions such as
  - What is the source of water for this stream you are sampling?
  - Is this river or stream a salmon (or other fish) bearing stream?
  - How might the water quality impact salmon these salmon?





## PART 3 RESILIENCY DURING CHANGE

### Questions for Inquiry

How does Traditional Ecological Knowledge in your region corroborate the evidence of climate change?

What are the strategies shared by Indigenous Knowledge for living sustainably in local environments and being resilient during episodes of climate change that all British Columbians can benefit from?

### Suggested Resources

- Locating local First Peoples resources and information
- Teach Climate Justice BC Resource: 8 modules valuable local action ideas at <http://www.teachclimatejustice.ca>

### Suggested Activities

#### 1. *PROBLEM-BASED LEARNING: A LOOK AT THE LOCAL EFFECTS OF CLIMATE CHANGE*

Explore options for action based community projects that students can become involved in and create change. This can help students identify the local impacts of climate change and roles they can play to support their community response. Two suggested resources are:

- The BC Climate Action Toolkit
- The Teach Climate Justice BC Resource
- Suggested Assessment: Products of Learning: Create a slide show, blog, online video, poster, or report

#### 2. *LESSONS IN RESILIENCY: FIRST CLIMATOLOGISTS*

Students can explore historical knowledge learned from the study of oral histories or by interviews with elders, storytellers and knowledge keepers (TEK).

They can discover ways in which Indigenous knowledge can be appropriately recognized and incorporated into strategies for adapting to and reversing climate change. There are information sheets provided, but it is more powerful for students to meet with community members and resources in the territory where they live.



## UNIT 5 • CLIMATE CHANGE

### **Inquiry Questions:**

- What key understandings have the First Peoples passed down through their oral histories and narratives about adapting to the changing nature of the land and seasons?
- What causes these changes and how are they dealt with for the well-being of the community and future?
- What are First Peoples noticing about the current changes to weather, climate and availability of species in their territories? How are the tools of contemporary science supporting these observations?
- What are the strategies all British Columbians can benefit from that have been passed down by the First Peoples?

### **Assessment**

Here are some suggestions for assessing the Essential Questions of the unit. See general suggestions for assessment in the Introduction, page 24.

1. How can Traditional Ecological Knowledge help scientists study climate change?
  - a. Have students develop a mind map that illustrates types of TEK that can assist scientists.
    - Students should consider both baseline data and observed changes.
  - b. As students progress through the unit, ask them to note in their journals special types of TEK that may be of use to scientists.
2. What can we learn from Indigenous peoples to help us live sustainably in the face of climate change?
  - a. Ask students to discuss the question, How can we look at climate change as First Peoples do – with an understanding that everything in the universe is connected?
    - Hold a class discussion and assess how students contribute to the discussion.
    - Ask students to write a journal response to the question.
  - b. Ask students to create a poster or other visual representation that advocates a relationship to the Earth that is similar to that held by Indigenous peoples.



## Additional Resources

BC Climate Action Toolkit. <http://www.toolkit.bc.ca>

Website with suggestions for how to take action with classes locally.

Canadian Wildlife Federation. Strangers in a Strange Land. Link at <http://bit.ly/2d3RBw7>

Online activities. Students explore the traditional wisdom of fishers, farmers, First Nations, and other peoples whose close relationship with nature gives them a deeper understanding of, and sensitivity toward, climatic cycles and events.

Climate Justice in BC: Lessons for Transformation.

<http://www.teachclimatejustice.ca>

Curriculum package examines climate change and rising inequalities. Includes 8 modules with embedded videos, downloadable graphics, Power Points, print-friendly PDFs, and additional resources is available free to use and adapt.

Heath, Joel and the Community of Sanikiluaq. *People of a Feather*. Video. 1 h 32 min. Documentary film about survival in a changing Canadian Arctic. Available on disk or through Vimeo.

Lee, Marc and Amanda Card. A Green Industrial Revolution: Climate Justice, Green Jobs and Sustainable Production in Canada.

[www.policyalternatives.ca/publications/reports/green-industrial-revolution](http://www.policyalternatives.ca/publications/reports/green-industrial-revolution)

A report on the industrial and employment strategies needed to transition to a sustainable economy and create a new generation of well-paying green jobs.

Macchi, Mirjam. Indigenous and Traditional Peoples and Climate Change. 2008.

[https://cmsdata.iucn.org/downloads/indigenous\\_peoples\\_climate\\_change.pdf](https://cmsdata.iucn.org/downloads/indigenous_peoples_climate_change.pdf)

A global report on the response of Indigenous people around the world to climate change.

Nye, Bill. Climate Change 101 with Bill Nye the Science Guy, Youtube video. Link at <http://bit.ly/1Za2D3f>.

Pacific Institute for Climate Solutions. Climate Insights 10.

<http://pics.uvic.ca/education>

Various teaching resources for the study of climate change.

*River of Salmon Peoples*. Theytus Books, 2015.

Memories, stories and voices of First Peoples living in the Fraser River watershed, including Musqueam, Lil'wat7ul Mount Currie, Secwepemc, Nle'kepmxcinm, Dakelh & Tsilhqot'in, Sardis Stó:Lō and Seabird Island Stó:Lō communities.

Sierra Club of BC. Education Learning Resource: Climate Change

<http://sierraclub.bc.ca/wp-content/uploads/2015/08/climate-change-learning-resource.pdf>

Telus World of Science. Salmon Migration Obstacle Course. Link at <http://bit.ly/2d6Ney0>

Through Arctic Eyes. 3 minute video. <http://bit.ly/2cSLeGB>

Impacts of climate change in First Peoples' communities in Yukon and Alaska.

Turner, Nancy J. and Helen Clifton. "It's so different today": Climate change and Indigenous Lifeways in British Columbia. *Canada Global Environmental Change* 19 (2009). Available online at <http://bit.ly/2dh4Unn>

An academic article on Indigenous perspectives on climate change. May be accessible by older students.

## Climate Change in the News



### **Canadian Chief: Aboriginal rights first step in fighting climate change**

By Marc Montgomery

Friday 4 December, 2015

Chief Bellegarde (Assembly of First Nations) was invited as part of Canada's official delegate to the conference and sat alongside Prime Minister Justin Trudeau, the Minister of Environment and Climate Change, and the Foreign Affairs Minister represented Canada at the opening plenary for the COP 21.

When Canada's Prime Minister spoke he mentioned the importance of traditional knowledge of Aboriginal peoples to be included in the effort to deal with climate change.

In an AFN press release, National Chief Bellegarde stated: "It is notable that the Prime Minister recognizes us as Indigenous peoples with all the rights articulated in the United Nations Declaration on the Rights of Indigenous Peoples, and that he understands that Indigenous peoples and our traditional knowledge are essential in finding solutions to combat climate change. We are the first to feel its effects and our voices and recommendations must inform the path forward. We fully expect that the final treaty negotiated here will reflect that."

Source: <http://bit.ly/2cSMPfD>

## **Evidence of Climate Change Over Time From First Peoples' Oral Histories**

Title of the Oral History / Narrative:

Who does the story belong to?:  
(i.e., First Nation, Community, and/or House group)

Who re-told this narrative?:

Describe the key events that happened in the narrative (i.e. flood, rise in sea level, migration, famine?)

What caused the event?

What were the consequences?

How were people affected?

## Salmon in Hay River? Local Fisherman's Catch Shocks Residents

A Hay River, N.W.T., fisherman's recent catch has left community members "shocked," and a biologist suggesting that climate change may be affecting the migration patterns of fish in the North.

While net fishing at the mouth of the Hay River Saturday night, Lorne Poitras caught a 10 kg chum salmon — a species that's not native to the N.W.T., much less the area.

The catch came as a surprise to Poitras, a self-described "traditional hunter and trapper" who was stocking up on fish for the winter months.

"I was pulling in my net," he said, "and I was taking my fish out like I normally do. I thought I caught a trout at first.

"And as it got closer, I'm realizing: 'Well, that's not a trout!' And then I looked, and I thought: 'That's a salmon!'"

Poitras said that he had heard of salmon being caught in Hay River before, but that "it's something that doesn't happen often, that's for sure.

"I was talking with some elders on the Hay River Reserve," he said, "and they said about 40 years ago, someone caught a salmon in the Hay River."

Lorne Poitras caught this salmon in his net at the mouth of the Hay River Saturday night — an unusual catch that had locals 'shocked,' he said.

Poitras shared a photo of his unusual catch on Facebook, which "shocked" community members, he said.

"They were about as surprised as I was," he said with a laugh.

'It's an access issue, and also an opportunity issue'

However, a PhD candidate at the University of Manitoba says that salmon numbers in the N.W.T. are increasing, likely due to the effects of climate change.

"They are certainly rare, but they're definitely not unheard of," said Karen Dunmall, who's studying the salmon population in the territory. "This isn't the first salmon harvested in Hay River... there are some records of salmon in Hay River in the past."

Dunmall said that despite year-to-year fluctuations, the number of salmon in the N.W.T. are generally increasing, saying that 'it's an access issue, and also an opportunity issue.

“There’s a couple of things that may be going on,” she said. “There is a possibility of increased access of salmon to the Mackenzie River system, or, possibly, there are spawning populations of salmon in the Mackenzie River, and changes may be occurring that allow increased populations to survive.”

Salmon enter the N.W.T.’s watershed system from the Arctic Ocean, says Dunmall, and the increased access could be due to warming temperatures, which lead to earlier melts each spring.

“You go back to the climate change issue,” she said. “The salmon may be indicating changes that are occurring – broader changes across the Arctic.”

Dunmall, who is working with the Department of Fisheries and Oceans, said that so far, her research has only documented increased access for salmon in the territory, but said that it’s possible salmon may be in the territory “looking for new areas to spawn in.

“They need areas in the Arctic that don’t freeze,” she said. “They’re not common, and they’re associated with groundwater springs.”

The Department of Fisheries and Oceans offers a reward for salmon caught in the Mackenzie River system, but it won’t be going to Poitras, who says that he ate half of his unusual catch, “and the other half is smoking right now.

“It was very good,” he said, laughing. “Me and the family really enjoyed it.”

Source: CBC website  
<http://bit.ly/2d3GUtg>





# UNIT 6

## SHAKING AND FLOODING

### Introduction

The land we know today as British Columbia was created by the forces of tectonic plates, building up rows of mountain ranges over long periods of geologic time. The landscape we inhabit has been shaped by diverse forces of nature, including tectonics, vulcanism, glaciation and erosion.

The BC landscape has always been subject to shaking and flooding thanks to earth quakes, tsunamis and the ongoing erosion of the earth's surface. With so much of our terrain at great heights, it's no wonder that gravity continues to shape the land. Add to that the effects of the substantial rainfall many parts of the province receive.

The last volcano in BC erupted only 300 years ago in the Nisga'a valley. There are an estimated 18 dormant volcanos waiting to reawaken in the province. They belong to what is known as the Northern Cordilleran Volcanic Province which extends through much of the interior of BC. Here the land is being stretched out through continental rifting.

Running along the coast, however, the Juan de Fuca plate is pushing eastwards underneath the continent. It is only a matter of time before the stresses that are built up suddenly let go. Then there is going to be some really big shaking and flooding going on.

For many parts of BC, particularly the coast, or those living near potentially unstable ground, preparing for major geologic events is an important consideration for daily life. Understanding the causes of earthquakes, tsunamis, landslides and seasonal flooding can help students be prepared for the future.



## First Peoples Connections

First Peoples have been witnesses to major geologic events for thousands of years. In fact they were the only witnesses prior to European contact.

Their knowledge of the geologic activity of the earth has been passed down through generations. Being oral cultures, these understandings have been embedded in stories. First Nations also memorialize geologic events through names, art and ceremonies. Today traditional narratives offer a different perspective on geological events that scientists are recognizing as important additions to the study of geology.

In one case, a very large seismic event that has been dated to 1700, appears in a number of oral histories of First Nations along the coast, from Vancouver Island south to northern California. By combining these narratives with radiocarbon and tree ring dating, and written records of a tsunami in Japan, scientists have been able to construct a full picture of what they call the 1700 Cascadia Earthquake.

First Nations continue to mark major geologic events. For example, following the magnitude 7.8 earthquake near Haida Gwaii in 2012, crest figures recognizing the quake were included on the Gwai Hannas legacy Pole, which was erected in 2013.



## PLANNING TO TEACH THE UNIT

This unit fits with the Learning Standards of Science 8.

### Outline of Activities

1. How the World Came to Be
2. Local Shaking and Flooding
3. Shaking and Flooding in Art and Ceremony
4. Evidence from the Past
5. Looking for Layers
6. Studying Tsunamis
7. How is Our Land Being Shaped?
8. Mind Mapping Geological Events

### Enduring Understandings

Important records of major geologic events over long periods of time have been passed down by First Peoples' through their oral histories.

The knowledge contained in oral histories about geologic events assists scientists in their understandings of geologic events, such as those which are the result of plate tectonics.

### Essential Questions

In what ways do traditional narratives about geologic events from the past contain important understandings about the earth's changing geological history?

How can scientists benefit from studying the earth's changing geology from a First People's perspective?



## Curriculum Connections

Suggested Topics and Inquiry Questions	Learning Standards
<b>Science 8</b>	
<p>First Peoples' relationship with the earth through knowledge of local geological formations</p> <ul style="list-style-type: none"> <li>• What connections do First Peoples' have with important geological features in their local territories?</li> <li>• What Traditional Ecological Knowledge do First Peoples' hold about local geological formations?</li> </ul>	<p><i>Curricular Competencies</i></p> <p>Identify First Peoples' perspectives and knowledge as sources of information</p> <p>Make observations aimed at identifying their own questions about the natural world</p> <hr/> <p><i>Content</i></p> <p>First Peoples' knowledge of local geological formations</p>
<p>First Peoples' knowledge of significant local geological events</p> <ul style="list-style-type: none"> <li>• In what ways have First Peoples' incorporated major geological events of the past into their cultural traditions?</li> <li>• How can First Peoples' knowledge about significant local geological events help scientists in their studies?</li> </ul>	<p><i>Curricular Competencies</i></p> <p>Experience and interpret the local environment</p> <p>Express and reflect on personal, shared, or others' experiences of place</p> <hr/> <p><i>Content</i></p> <p>Major geological events of local significance</p> <p>First Peoples' knowledge of significant local geological events</p>



## Suggested Resources

- Traditional narratives that describe how local physical features came to be created, such as *People of the Land: Legends of the Four Host First Nations*. See suggestions in Additional Resources at the end of the unit.
- Cheryl Coull, *A Traveller's Guide to Aboriginal B.C.* Whitecap Books, 1996.

## Suggested Activities

### 1. HOW THE WORLD CAME TO BE

Provide students an opportunity to hear or read origin stories that explain how local physical features came to be. Often these are found in Transformer or Trickster tales.

- If possible, invite an Elder, knowledge keeper or language teacher into the class to tell an origin story. See suggestions for bringing a speaker into the class, page 14.
- Find published stories that explain the origin of physical features to read aloud or have students read. See some suggestions in Additional Resources below.
  - For example, see the book *People of the Land: Legends of the Four Host First Nations*. It includes a number of stories, including the Transformer story of Lil'wat People: Creation of Lil'wat Territory which gives examples of how the Transformers left their imprint on the land through a number of rocks visible today, as well as creating the kingfisher, and teaching people how to fish.
- Where possible, visit a local landmark that is connected to a traditional narrative. If a visit is not possible, show pictures or videos of the feature.
- Mountain stories. Often there are stories associated with mountains that may be visible from the school. For example:
  - Students in the Vancouver may be able to view what are known as The Lions in the mountains north of the city. For the Squamish, the twin peaks are the Sisters. The story is told in *People of the Land: Legends of the Four Host First Nations*, page 81.
  - Mount Cheam and Mount Baker, visible in much of the Lower Mainland, have connected stories. See the website Man Turned to Stone, T'xwelátse. Link at <http://bit.ly/2cIAGMG>
  - Ts'ył'os (Mount Tatlow) is the highest peak in the Chilcotin range, with spiritual significance to the Xeni Gwet'in First Nation.



## UNIT 6 • SHAKING AND FLOODING

### 2. LOCAL SHAKING AND FLOODING

Have students work together to create a class display about significant local geological events.

- a. Discuss with students how they will collect the data. Where can they find the information?
  - Some suggestions include interviewing family members or consulting the local library, archives or museum, as well as online searches.
- b. Students can investigate the biggest earthquakes in their region since 1985. Use the Earthquakes Canada website, <http://earthquakescanada.nrcan.gc.ca/>
  - Go to “Earthquake Search” in the left hand menu.
  - Change some of the given search parameters to bring up earthquakes in your region.
    - Change the Date.Time “From” field to 1985/01/01
    - Under Region, select “Radius.”
    - Under Radius options, enter the Latitude and Longitude of your community. (The longitude needs to be a negative number for BC.)
    - Entire a desired radius around your community, perhaps 100 or 200 km.
    - Select a sorting option. You can view by date order, and also list them in order of how strong they were (magnitude).
    - Students can list or map the ten largest earthquakes in their region since 1985.
- c. Where is the closest volcano? Have students investigate the ancient and dormant volcanoes in BC to see how close they are to your community.
  - Note: There are around 100 ancient volcanoes identified in BC, while there are 18 that are considered dormant and potentially active. You may want students to consider all volcanic evidence, or just the more prominent dormant volcanoes. The long list can be found on Wikipedia (List of Northern Cordilleran volcanoes, or List of Volcanoes in Canada.) Several online sites show the dormant volcanoes in British Columbia.
  - When students find out the nearest volcano, have them determine the approximate distance from their community, and the estimated time period when it last erupted.
    - Further information can be collected about the volcano, such as the type of volcano, and what the land looks like today. Students may collect pictures of the volcano as it appears today.
  - Ask students to imagine how the local area would have been impacted by the nearest volcano when it erupted. Was it close enough to have shaken the ground? Would lava flows or ashes covered the ground?
- d. Research other geologic events, including landslides, flooding and tsunamis.
- e. Have students determine if there is any observable evidence of local geological events. If possible, have them document the evidence with photographs or video.



- f. Ask students to find out if there are any First Nations connections with these events. Were there any witnesses? Are these events mentioned in any traditional stories or other cultural aspects?
- g. Map the information about local geological events. You may want to do one big class map, or have students work in groups.

### 3. SHAKING AND FLOODING IN ART AND CEREMONY

Study the connections First Peoples have with major geologic events by exploring representations in First Nations art ceremony. Some examples are:

- a. Gwaii Haanas Legacy Pole. This pole includes crest figures commemorating the 2012 earthquake that hit Haida Gwaii.
  - View a video in which the artist explains the crests carved on the pole: *Gwaii Haanas Legacy Pole Crests*, on Youtube at <http://bit.ly/2dFmN0I>
  - Search online for other sites that describe the crests of the pole.
- b. Earthquake represented in masks. The Kwakwaka'wakw and Nuxalk Nations use masks representing the Earthquake in traditional dances and ceremonies.
  - Students can search online or in reference books to find images of Earthquake masks

### 4. EVIDENCE FROM THE PAST

Have students explore how First Peoples' oral histories and scientific research into major geologic events complement each other, and how knowledge contained in oral histories helps scientists understand past events.

- a. 1700 Cascadia Earthquake. Students can investigate how scientists used traditional narratives to help understand a major earthquake that occurred 300 years ago.
  - Two sources are readily available online:
    - Dating the 1700 Cascadia Earthquake: Great Coastal Earthquakes in Native Stories. <http://ow.ly/nRdU303sTj5>. This is a scientific report presenting the scientists' finding.
    - Searching for Native Stories about Cascadia Subduction Zone Earthquakes. <http://ow.ly/TSGB303sTyd>. This is a poster in pdf form about the connections between First Nations oral histories with Cascadia Subduction zone earthquakes.
- b. Other areas of study include:
  - Nisga'a lava beds (volcanic eruption)
  - Gitxsan narrative of the Mountain Goats of Temlaham (landslide)
  - Creation of the Rocky Mountains



## UNIT 6 • SHAKING AND FLOODING

### 5. LOOKING FOR LAYERS

If possible, locate a nearby geologic feature in the local area such as mountains, hills or cliffs that shows exposed stratification, or layers of rock and soil. Have students visit the site to document the layers.

- a. In the field, ask students to examine the layers and describe them in their notebook. They could include colour, texture, what they are made of, direction they lay.
- b. Have students sketch the feature in cross section.
- c. In the field or in the class, discuss how the layers came to be. Depending on the nature of the feature and the grade level of students, you can discuss the relevant geological processes involved.
- d. Students can make a model of the feature with plasticine or other material.

### 6. STUDYING TSUNAMIS

Students can investigate the causes and effects of tsunamis through a series of activities developed by Ocean Networks. These include lab activities and data interpretation using information gathered by Ocean Networks deep sea sensors.

- a. What causes tsunamis? Students build a model to demonstrate how tsunamis are propagated. See the link at <http://bit.ly/2d7sYe7>.
- b. Graphing Tsunamis. Students use NEPTUNE Canada data to graph tsunamis that have occurred off the coast of Vancouver Island.  
Link at <http://bit.ly/2dwUdON>
- c. Tsunami impact and slope relationship. Students conduct experiments to determine how the shore slope affects the overall impact of a tsunami.  
Link at <http://bit.ly/2dpMbLs>
  - Schools in coastal communities could investigate how the shore slope might impact their community in the case of a tsunami.
- d. 40 Seconds Extra Warning Students build emergency response plans for different parts of their community, based on the idea that citizens have received 40 seconds warning of intense shaking, and 30-40 minutes advance warning of a Tsunami. <http://bit.ly/2d7tkkW>





### 7. *HOW IS OUR LAND BEING SHAPED?*

Ask students to investigate how plate tectonics and other geological forces have shaped your local region in the past, and what evidence remains today.

- a. Work as a class to decide how to represent the information they uncover.
  - In some cases a map might be appropriate, in other a poster with pictures of different sites may work better.
- b. Ask students to determine how the effects of geological forces in the local landscapes affects daily life in your community.
- c. Discuss with students the level of risks your community faces from future geological activity.

### 8. *MIND MAPPING GEOLOGICAL EVENTS*

Have students create a mind map to summarize their learning about geological events locally and throughout the province.

- a. The scope of the Mind Map will depend on the extent of the earth sciences you have studied in conjunction with this unit.
  - Mind maps may include key elements of what the topics they have studied, such as plate tectonics, volcano, gradual and sudden changes in Earth as well as connections to oral history.
  - Students will analyze what they have learned, make connections between ideas, and synthesize their thinking to produce a representation of their thinking.
  - Mind maps may be done on paper, electronically, or in other media. This assignment can be done individually or in groups.
- b. Ask students to reflect on the question: “How does studying changes on the earth reveal secrets from the past and impact our future?”



## UNIT 6 • SHAKING AND FLOODING

### Assessment

Here are some suggestions for assessing the Essential Questions of the unit. See general suggestions for assessment in the Introduction, page 24.

1. In what ways do traditional narratives about geologic events from the past contain important understandings about the Earth's changing geological history?
  - a. Ask students to draw a map of the local area that includes significant geological features that have connections to the local First Nations, such as stories about how they were created.
  
2. How can scientists benefit from studying the earth's changing geology from a First People's perspective?
  - a. Have students create a T-chart, Venn diagram, or other graphic organizer that compares a scientist's understanding of geological events with those of First Peoples.

### Additional Resources

Cheryl Coull. *A Traveller's Guide to Aboriginal B.C.* Whitecap Books, 1996.

Nisga'a Lisims Government. *Volcano*. <http://www.nisgaanation.ca/volcano>

Finkbeiner, Ann. The Great Quake and the Great Drowning. *Hakai Magazine*. 2015. Online link at <http://bit.ly/2dhLjn7> or search title keywords.

Ktunaxa Nation Creation Story. Ktunaxa Nation website. <http://www.ktunaxa.org/who-we-are/creation-story/>

In preparation for the arrival of humans, the animals chase a terrible monster through the Ktunaxa territory. The story of the chase names places throughout the region. Events following the defeat of the monster end up creating physical features, including the Rocky Mountains.

Ludwin, Ruth S. *Searching for Native Stories about Cascadia Subduction Zone Earthquakes*. <http://ow.ly/TSGB303sTyd>

Ludwin, Ruth S. et al. Dating the 1700 Cascadia Earthquake: Great Coastal Earthquakes in Native Stories. *Seismological Research Letters* Vol 76, no. 2. March/April 2005. Available online at <http://ow.ly/nRdU303sTj5>

*People of the Land : Legends of the Four Host First Nations*. Theytus Books. 2009.

Stó:lō Nation and The Reach Gallery Museum. *Man Turned to Stone* website. Abbotsford. Link at <http://bit.ly/2dxcNGI>



# UNIT 7

## INTERCONNECTEDNESS OF THE SPHERES

### Introduction

The atmosphere, biosphere, geosphere and hydrosphere are the four main systems that dictate life on earth. All systems are interconnected as matter and energy flow from one to another. The scientific understanding of interconnectedness of the earth's systems generally differentiates between the animate and inanimate.

A central understanding of Indigenous Knowledge is that everything in the universe is related. This belief in the interconnectedness of all things tends towards a different view of humans relationships with the environment than that of the long-standing Western thought in which humans are separate and often above the rest of other living things.

Stewardship and sustainability are inherent in most Indigenous world views. The responsibility for caring for the land and the need to ensure that resources are not depleted or diminished, but are sustained, are also important tenets in ecological sciences.

Humans, as an integral part of the Earth system, place increasingly significant pressure on the earth's systems. At the same time as unsustainable resource use practices continue, there is a growing effort to reverse the negative impacts of humans on the environment. Scientists are acknowledging the significance of Traditional Ecological and the Indigenous view of Interconnectedness in making environmental and resource management decisions.

This unit explores the theme of Interconnectedness from Indigenous and Western Scientific perspectives. It examines crucial interactions between diverse parts of the Earth system, to see how everything is connected.



## UNIT 7 • INTERCONNECTEDNESS OF THE SPHERES

### **First Peoples Connections**

First Peoples of British Columbia carry scientific knowledge learned through untold generations of experiences with the land and ecosystems. Valuable lessons have been learned and built upon over the sharing of this knowledge through stories and experiences, ultimately surviving in a sustainable and respectful way.

First Nations have survived in their unique territories through their knowledge which has enabled them to live sustainably using the resources available to them.

Most First Peoples worldview includes the idea that everything in the universe is related. This is sometimes called by academics a “kincentric belief system” and the study growing out of it kincentric ecology.

This worldview, which can be expressed as Interconnectedness, includes not only plants and animals, but all parts of the universe, the rocks, lakes and stars. The oral histories of the many First Nations in BC and beyond are rich with stories where plants, animals, mountains and stars are portrayed as sentient and powerful.

Viewing all aspects of the natural world as your relatives demands a respectful and caring approach to use the resources. From Indigenous perspectives, the land is generously providing gifts to humans, and people have the responsibility of reciprocating this generosity.



## PLANNING TO TEACH THE UNIT

This unit links directly to the Content Learning Standards for Science 5 and Science 9. As well, the theme of Interconnectedness may be included in topics covered in other grades.

### Outline of Activities

1. Interconnectedness
2. Family Connections
3. Connecting With Nature
4. Connecting the Spheres
5. Carbon Sequestration in Trees

Catch It – Modelling Problem Based Learning

### Enduring Understandings:

First Peoples understanding and respect of these spheres has allowed them to survive and live in a sustainable manner.

### Essential Questions:

How do Earth's major spheres interact?

How do First Peoples view the cycling of matter and energy?



Curriculum Connections	
Suggested Topics and Inquiry Questions	Learning Standards
<b>Science 5</b>	
First Peoples’ understanding that everything in the natural world is connected <ul style="list-style-type: none"> <li>• How would people treat the environment if they believed we are all related to everything in the natural world?</li> </ul>	<i>Curricular Competencies</i> Identify First Peoples’ perspectives and knowledge as sources of information  Express and reflect on personal, shared, or others’ experiences of place
	<i>Content</i> First Peoples’ concepts of interconnectedness in the environment
<b>Science 9</b>	
First Peoples’ understandings of interconnectedness <ul style="list-style-type: none"> <li>• What can we learn from First Peoples’ traditional knowledge about the interconnectedness of the all parts of the universe?</li> <li>• How can we apply First Peoples’ perspectives on interconnectedness for a sustainable future?</li> </ul>	<i>Curricular Competencies</i> Apply First Peoples’ perspectives and knowledge, other ways of knowing, and local knowledge as sources of information
	<i>Content</i> First Peoples’ knowledge of interconnectedness and sustainability



## Suggested Resources

- *Legends and Teachings of Xeel's, the Creator*, by Ellen Rice White
- *River of Salmon Peoples*, Theytus Books 2015
- chart paper
- sticky notes
- measuring tape
- graphing paper
- internet access

## Suggested Activities

### 1. INTERCONNECTEDNESS

Provide students an opportunity to understand the concept of Interconnectedness as a central part of First Peoples' understandings of the world. Below are some suggestions for approaching this topic with your students.

- Find out if there is a word or phrase in the local First Nations language that expresses the idea of interconnectedness.
  - For example, the Nuu-Chah-Nulth say *Hishuk ish ts'awalk* which means "everything is one." In Haida, it is *Gina 'waadluxan gud ad kwaagid*; "Everything depends on everything." In Secwepmc, *Kweseltnews* means "We are all family."
  - If you have First Nations language classes in your school, perhaps the language teacher could help students develop their own phrase in the language.
- Invite an Elder or knowledgeable First Nations speaker to discuss examples of interconnectedness in the local First Nations culture.
  - If possible ask them to tell a story that illustrates the idea that everything is connected.
- Read the traditional story "The Creator and the Flea Lady from *Legends and Teachings of Xeel's, the Creator*, by Ellen Rice White. This book was prepared for secondary students and includes four stories and commentaries by Snuneymuxw Elder Kwulasulwut (Ellen White). This short story clearly illustrates many strands of the Interconnectedness of people with the universe.
  - In this story the little flea lady is overwhelmed when her baby is near death. She calls to Xeel's the Creator for help. "I know you are out there somewhere. You are in the water, in the air, in the sky, in the earth." She gets the help she needs, from the energies of the universe, from the sand and rocks, and from her family. They work to build an ingenious incubator, using the elements of the land and sea.
  - In a commentary that follows, Ellen discusses the ideas in the story, including the ideas of our connections with the universe. "The universe is made of energy. All things, inanimate as well as animate, are imbued with it; and we



## UNIT 7 • INTERCONNECTEDNESS OF THE SPHERES

are all connected by universal energy” (p 20.)

- Discuss with students the examples of natural, social and spiritual connections the Flea Lady had. Students could illustrate the connections to demonstrate their understanding.
- e. Use other stories, narratives and personal accounts, local ones if possible, to illustrate the idea of interconnectedness.
- *River of Salmon Peoples* contains some good discussions of interconnectedness, such as
    - p. 22 Dakelh community, “what happens in one area of the river affect what happens upstream or downstream.”
    - p. 33 Sardis Stó:Lō, “The Fraser is the main artery of Mother Earth for us.”
    - p. 71 Musqueam, “Our traditional viewpoint is to regard the salmon as brethren with spirits of their own.
    - p. 97-99 Sardis Stó:Lō, relationship of salmon, the river and the people
    - p. 113, Musqueam, paying respect to salmon, trees when harvesting them
    - p. 116, Seabird Stó:Lō, “What we call a relational world view is where everything is interconnected and related.”
- f. Make a word wall of words related to the idea of interconnectedness, such as holistic, unified, integrated.

### 2. FAMILY CONNECTIONS

Ask students to consider the question, How is the world view of most First Peoples like a family relationship?

- a. Discuss the feelings, responsibilities and obligations most people feel towards other members of their family.
- b. Ask student to discuss how a belief that everything in the universe – living things, rocks, rivers, lakes and stars – are our relatives would affect the way that we treat the environment.

### 3. CONNECTING WITH NATURE

If possible, take students on a guided nature walk to experience a local ecosystem and observe ways that everything is connected. Ideally it would be lead by an Elder or knowledge keeper of the local First Nations community.

- a. The nature of the walk will depend on many factors – locality, time of year, interests of the Elder or leader. Design an experience for students that best suits your situation.
  - If an Elder or First Nations knowledge holder is not available, it is still possible to undertake the activity.
- b. Planning and preparation are essential for a successful walk. Make sure any school and community protocols are followed.





- c. One source to guide your planning is Walking with the Earth - Pimohtiwin: Lessons to Support Science 10. Although it is oriented towards Saskatchewan First Nations, it has many suggestions that can be adapted. Search for the title to locate on the internet, or go to this link: <http://bit.ly/2czWyX3>.

#### 4. CONNECTING THE SPHERES

Introduce or review the scientific perspective on the interconnectedness of the earth's systems or spheres: atmosphere, biosphere, geosphere (also called the lithosphere) and hydrosphere.

- a. Use available resource materials as a focus for discussion. One suggestion available online is a six minute video *Earth's Systems Interact*, found at the link <http://bit.ly/2dxPXyw> or search for title keywords.
- Videos that describe the four spheres in an engaging way (but do not talk about interconnectedness) are Four Spheres Part 1 (Geo and Bio) and Four Spheres Part 2 (Hydro and Atmo) online at Youtube. For links go to <http://bit.ly/2ddXDql> and <http://bit.ly/2dq47kW>.
- b. Sphere stations. This activity encourages students to make connections between the spheres to demonstrate how everything is dependent on everything else.
- Around the classroom put five pieces of chart paper labelled Sun, Atmosphere, Biosphere, Geosphere, and Hydrosphere.
  - Divide students into five groups and provide each group with a different colour of sticky notes.
  - The groups will rotate through each of the stations. At each station they write on the sticky notes ways that the subject interacts with the other spheres.
  - Add the note to the poster.
  - At the end, the teacher or students can read aloud some of the responses.
- c. Web of life activity. You will need a ball of string and a list of organisms.
- Give each student the name of an organism. One can have the sun.
  - You may have prepared cards or have students write assigned words on a piece of paper.
  - The person holding the sun tosses the ball of string to someone else in the circle, making sure they hold onto the end of the string.
  - The person who catches the string tells one way that their organism interacts with the sun.
  - Students continue tossing the ball of string, holding onto their section of string so that it forms a web. Each person gives a way their organism interacts with the previous organism.
  - If someone gets stuck, others can help out.
  - Eventually a tangled web will be created.
  - Discuss what would happen if one of the objects was removed from the web. Ask how this is similar to a real ecosystem.



## UNIT 7 • INTERCONNECTEDNESS OF THE SPHERES

- d. Ask students to compare the two principles of interconnectedness. How are they similar and different.

### 5. CARBON SEQUESTRATION IN TREES

Have students estimate the biomass and nutrient content of trees around your school and calculate the approximate carbon content. (This calculation is adapted from the activity “Carbon in the Classroom: found online at <http://bit.ly/2dKrwB5>)

- a. Select the area for your field study. There should be enough trees for small groups of students to each have a study tree.
- b. In the field, have students record data about their tree.
- Record information about their tree, such as location, species.
  - Measure the diameter of the tree at about 1.3 m from the ground.
- c. In the class, have students calculate the approximate biomass using the calculator at the Natural Resources Canada website, <http://bit.ly/2dKs4H6>
- The biomass calculator gives separate biomass readings for bark, branches, foliage and wood. Students should give the total of these figures.
  - Add to this figure the approximate biomass for the roots by multiplying by 1.26.
- d. From the rough biomass calculation, students can determine the carbon that might be stored in the tree.

#### Example calculation of carbon sequestration

Western red cedar

diameter at 1.3 m: 20 cm

Biomass calculation (from NRC calculator)

bark 5.42 kg

branches 20 kg

foliage 11.54 kg

wood 49.17 kg

Total: 86.13 kg

tree + roots biomass  $86.13 \times 1.26 = 108.52$  kg

Approximate carbon stored in tree

$108.52 \times 0.5 = 54.26$  kg

Approximate CO<sub>2</sub> sequestered in the tree:

$54.26 \text{ kg} \times 3.7 = 200.77$  kg

- Multiply the approximate biomass by 0.5.
- Multiply the result by 3.7. This figure gives the approximate amount of carbon dioxide stored in the tree in kilograms.

e. What do the numbers mean?

Ask students to find some examples of CO<sub>2</sub> emissions and compare with the amount of CO<sub>2</sub> their trees are sequestering.

- For example, a jet flight from Vancouver to Prince George, about 500 km distance, produces about 152 kg of CO<sub>2</sub>.

f. Interconnectedness of the spheres

Ask students to discuss how this calculation illustrates the ways that the spheres are interconnected. What are the main spheres involved? (i.e. biosphere, atmosphere,) How are the other spheres impacted?



## Assessment

Here are some suggestions for assessing the Essential Questions of the unit. See general suggestions for assessment in the Introduction, page 24.

1. How do Earth's major spheres interact?
  - a. Have students explain some ways that the spheres interact by creating a diagram that shows the spheres in relation to the local region.
2. How do First Peoples view the cycling of matter and energy?
  - b. Ask students to work collaboratively to discover examples of First Peoples perspectives on cycling of matter and energy.

## Additional Resources

*River of Salmon Peoples*. Theytus Books, 2015.

Memories, stories and voices of First Peoples living in the Fraser River watershed, including Musqueam, Lil'wat7ul Mount Currie, Secwepemc, Nle'kepmxcinm, Dakelh & Tsilhqot'in, Sardis Stó:Lō and Seabird Island Stó:Lō communities.

Saskatchewan Teachers Federation

The following teachers resources are from the Saskatchewan Teachers Federation. They included activities from the perspective of Saskatchewan First Nations and Métis, they have useful suggestions that can be adapted for BC. They are all available online and are best accessed by doing a keyword search on the title.

Klein, Marcia. *Walking with the Earth - Pimohtiwin: Lessons to Support Science 10*. Saskatchewan Teachers Federation. Online at <http://bit.ly/2czWyX3>.

View, Ted. *From Mission to Action: Lessons on Sustainability of Ecosystems to Support Science 10*. Saskatchewan Teachers Federation, 2008. Online. Locate with title keyword search or link at <http://bit.ly/2d236AZ>.

Wright, John. *Cultural Perspectives on Sustainability: Lessons to Support Science 10*. Saskatchewan Teachers Federation, 2008. Online. Locate with title keyword search or link at <http://bit.ly/2czWJ4E>.

White, Ellen Rice (Kwulasulwut). *Legends and Teachings of Xeel's, the Creator*. Pacific Educational Press, Vancouver, 2006.



## CATCH IT

### MODELLING PROBLEM BASED LEARNING (PBL)

Surrey School District

#### Introduction

This section presents an example of a Problem Based science unit in action. It illustrates the results of one classes' participation. Hopefully it will serve as a model for teachers to plan their own Problem Based Learning (PBL) activities.

PBL is an important strategy to use when teaching science from a First Peoples' perspective. It shows clearly a variety of learning standards, uses inquiry, and has a First Peoples lens that is addressed throughout.

Problem Based Learning provides an opportunity for students to create learning opportunities based on three elements. According to Dr. Shelagh Gallagher (*Problem Based Learning in Your Classroom*) the elements include:

- using an ill-structured problem to initiate learning,
- requiring students to adopt a single stakeholder role, and
- emphasizing coaching over transmitting information as the primary form of instruction

The activities illustrated below were conducted over a week of class time that focussed on cross-curricular inquiry. The class came together through consensus to decide on the questions and themes for their learning priorities. They then determined in which order the learning should occur.

Throughout the process the teacher guides the learning with kickers, activities and if necessary extensions. In this example the teachers used videos, hands on activities (dissections), guest speakers and kickers.

Kickers are additional or new information that can bring twists in the story, and cause students to modify their previous thinking. In some cases these kickers were made by the teacher, and others used texts found in various newspapers or online.



**Enduring Understandings:**

All life is connected. Systems rely on systems to thrive and sustain.

**Essential Questions:**

How are the systems within the river interconnected?

**Science Curricular Connections**

Grade 5:

- local types of earth materials
- First Peoples concepts of interconnectedness in the environment
- the nature of sustainable practices around BC's resources
- First Peoples knowledge of sustainable practices

Grade 6:

- local First Peoples knowledge of separation and extraction methods

Grade 7:

- survival needs
- evidence of climate change over geological time and the recent impacts of humans
- local First Peoples knowledge of climate change

Grade 8:

- characteristics of life
- the relationship of micro-organisms with living things
- plate tectonic movement
- major geological events of local significance

Grade 9:

- matter cycles within biotic and abiotic components of ecosystems
- effects of solar radiation on the cycling of matter and energy
- sustainability of systems
- First Peoples knowledge of interconnectedness and sustainability

**S'OLH TEMEXW TE IKW'ELO. XOLHEMET TO MEKW'STAM IT KWELAT.**  
(This is our land. We have to look after everything that belongs to us.)

---

January 18, 2016

Memo to: Sxélcha (Lower Mainland Fish Advisory Consultant Group)

RE: Sasquatch Fish Farm Application Proposal 2015-8999

Thank you for your immediate response to our request. Please find enclosed the recent minutes from the Stó:lō Tribal Council meeting held on Wednesday, August 26, 2015.

As the current committee in consultation with the Stó:lō Tribal Council and the Sasquatch Fish Farm application, we felt that the consultant group should be aware of some of the issues raised by Elders from several of the communities relating to the application in question.

1. Significant fish stock decline
2. Loss of food access
3. Decrease in traditional practices
4. Future concerns for fish sustainability

In addition, we would like to extend an invitation to the Lower Mainland Fish Advisory Consultant Group to present your impact study of opening a fish farm on the Chilliwack River. This application is for a fish farm located within the traditional territories of several First Nation communities.

It would be beneficial to the Tribal Council if you could provide more information about where and why there has been a decline in fish stock as well as additional recommendations for sustainable and improved practices in fish recovery. The next Council meeting will occur on March 12, 2016 at which time the Elders and other community members will be present to hear your findings.

All my relations.

Stó:lō Tribal Council

Minutes for Wednesday, August 26, 2015:

Issue 1: group of Elders from the different communities enter the big house and place a large, empty fish bucket on the floor demanding to know why for a second straight year the food fish opening been banned. They are concerned about how their communities will survive yet another year without proper access to fish and what will happen if this occurs again next year.

Recommendations Issue 1: meet with Elders to review historical changes and understand previous changes to fish stocks from past events

Issue 2: presentation for an application by the Sasquatch Fish Farm licence situated on the Chilliwack River between traditional territories by the Lower Fraser Fisheries Alliance

Recommendations Issue 2: contract the Sxélcha (Lower Mainland Fish Advisory Consultant Group) to create an impact study on farm fishing and the fish stocks in the Chilliwack River and address some of the concerns from our Elders

Issue 3: financial statements for 2014 reviewed by the Auditor

Recommendations Issue 3: Continue with regular audit review, February 2016.

Issue 4: committee reviews – nothing to report

Recommendations Issue 4: Education to report October 2015 once school reconvenes, Social Development to continue with Auditor to address needs in the communities – address additional concerns for November 2015.



### Learning Issues

- What kinds of salmon thrive in fish farms?
- What are the pros and cons of fish farms?
- What are the traditional ways of fishing and how do fish farms impact those ways?
- What is the ideal location for a fish farm?
- What are the alternatives?
- What are the environmental impacts of fish farms?
- What is the Indigenous perspective on fish farming?
- What are the government/licensing criteria for fish farms?
- Who is the Stó:lō Tribal Council?
- Where are the communities of the Stó:lō Tribal Council located?
- What types of fish run in the Chilliwack River? When?
- What is the role of the Elder?

### Introducing the Problem

In this unit the students took on the stakeholder role of a consulting company that has been asked to report to the Sto:lo Tribal Council about the dwindling food fish resources available along the Chilliwack River.

The setting includes a community forum being held to address the declining salmon numbers returning to the Chilliwack/Fraser River. The stakeholders need to be prepared to field questions from a variety of interested groups who each blame competing groups for the declining fish numbers.

The community forum is intended to help all stakeholders realize the complexity of the issue and to get them to come to consensus, agreeing that everyone has a vested interest and can contribute to a common solution in which ensures the increase to the salmon stocks.

The investigation began with the memo from the Stó:lō Tribal Council and the minutes of a Council meeting. (See samples on the following two pages.)

The students discussed questions such as:

- What is being asked?
- What do we need to learn before we can provide feedback and answer questions?
- What is our role?





## Creating a Plan for Learning

Once the problem was understood, the class as a group created a plan for learning, considering questions such as:

- What questions do we have?
- Can the questions be grouped into themes or categories?
- What are the priorities? What do we need to learn first, second....

It is important that the Plan for Learning be decided by consensus, not by a vote. During consensus students are able to articulate their reasons, learning and make connections. Consensus is what First Peoples traditionally would have used to make group decisions.

The questions and priorities were formulated into Learning Issues, shown below. These became the focus of inquiry.

## Problem Solving in Action

The class, working together, developed the following sets of topics and questions, then set about finding answers to them. Along the way teachers added additional input through kickers and extension activities.

### *GEOGRAPHY & TRADITIONS*

- Where do the Chilliwack and Fraser River connect?
- What communities are along the Chilliwack River?
- What is the surrounding environment?
- Are there any spawning grounds along the Chilliwack?
- Where are the traditional and sacred fishing grounds?
- Who is the Stó:lō Tribal Council?
- Where are the Stó:lō communities located?
- What is an Elder?

- Extension activity: the class went on a nature walk along the Fraser River.

### *SALMON*

- What types of salmon are in the Chilliwack River?
- What are the traditional ways of fishing and commercial ways of fishing?
- What are the different traditional uses of salmon along the Fraser?
- How are fish numbers determined?
- What is the salmon cycle on the River?
- What has happened to the spawning grounds?



## UNIT 7 • INTERCONNECTEDNESS OF THE SPHERES

- Extension Activity: dissect a farmed salmon and a wild salmon (same species). What is the same/different?
- Kicker: Students viewed a commercial for Fraser River Fishing Trips.

### *FISH FARMS*

What is a fish farm?

What kind of fish thrive in fish farms?

How do fish farms impact natural fish cycles?

What are the environmental impacts of fish farms – long term/short term?

What are the government's licensing criteria for fish farms?

What happens to the fish that are farmed?

Why do farmed salmon get diseases?

- Extension Activity: Invite guests to come and talk with the students on the pros and cons of fish farms (can be done electronically). Set up a class debate.

### *ENVIRONMENT*

What is the optimal river temperature needed for salmon to thrive?

How do water levels impact salmon runs and spawning?

What other environment impacts might be effecting the number of salmon?

What other fish or wildlife depend on the river?

What other indicators are present to show the river and salmon are not thriving?

What is the predictive pattern over the next four years?

- Extension Activity: How many commercial fish licenses are handed out each year? How many recreational fishing licenses? What are the fishing number restrictions for the licenses?
- Kicker: News article on garbage in the ocean.

### *DEVELOPMENT AND RESOURCES*

What forms of development and resources are dependent upon the rivers?

What environmental impacts may occur?

What is meant by sustainability?

How has the river bank changed in the past 100 years?

What impact has agriculture had on the health of the river?

- Extensions Activity: Watch a video on the building of the Site C Dam – flooding of land, removal of culture, loss of homes. Create a model or digital impression of what the territory would look like 25 years from now if the dam is no longer working. For example: using sticks and natural materials, reroute a model of



a stream created by students to show the impact of debris, development and change of landscape.

- Kicker: News release: The BC Government has just approved a dam to be built.

### **Cross Curricular Activities**

A number of additional activities were undertaken to support cross curricular learning:

- Letter writing
- Interview skills
- Debate skills and processes
- Protocols & Presentation skills
- Data analysis
- Map reading
- Math – predictions and statistics

### **Assessment**

*FORMATIVE ASSESSMENT SUGGESTIONS:*

Weekly reflections – see Blackline Master “Problem Log” and “Reflection”

*SUMMATIVE ASSESSMENT SUGGESTIONS:*

Prepare an impact report, presentation, or display that supports your role with Sxelcha. As a class determine the curricular competencies that need to be assessed and the content that has been learned.



## UNIT 7 • INTERCONNECTEDNESS OF THE SPHERES

### Suggested Resources

Map of Sto:lo territories:

[http://www3.bc.sympatico.ca/thom/stolo\\_map.htm](http://www3.bc.sympatico.ca/thom/stolo_map.htm)

First Voices website for language translation and pronunciations guide

<http://www.firstvoices.com>

Fisheries and Oceans Canada website:

<http://www.dfo-mpo.gc.ca/index-eng.htm>

Ministry of Forests, Lands and Natural Resource Operations

<http://www.env.gov.bc.ca/fw/>

Aboriginal Fisheries Research Unit

<http://aboriginalfisheriesresearch.com/>

Issues 21 –Scholastic Resources

Including topics of overfishing, climate change, oceans

*Stolo Historical Atlas* (includes extensive history of Stolo traditional territories)

*You Are Asked to Witness: The Sto:lo in Canada's Pacific Coast History*

Lower Fraser Fisheries Alliance: Fishers Working Together (Sp'èptset Syoyes Sth'ò;th'èqwi) – DVD

*Problem Based Learning in Your Classroom* Shelagh Gallagher

## Blackline Masters used during the unit

### Creating a Learning Plan

What Do I Know?	What Questions Do I Have?	What are the Learning Issues (Priorities)

### Plan of Action

Learning Issue or Question	What is my Plan to Learn More?

### Problem Log – My Learning

<p>Learning Issue:</p> <p>Resources Used:</p> <p>Notes:</p>
---

### Learning Issues Reflection

What did I learn?

What question(s) do I still need to address?

### Problem Definition

What is the problem we are trying to find a solution for?

What is the solution?

### Presentation Notes

How will you present your findings to the Council?

What do you think the term “interconnected” means based on your findings and presentation to the Council?

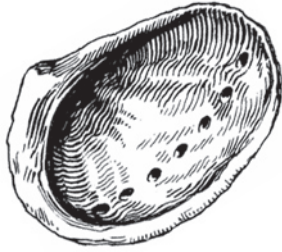

# UNIT 8

## OCEAN CONNECTIONS

### Introduction

A group of concerned scientists and educators describe a full understanding of the ocean's influence on humans, and humans' influence on oceans, as "Ocean Literacy." An ocean-literate person understands some essential principles and concepts about the ocean, can communicate about the ocean in a meaningful way, and is able to make informed decisions regarding the ocean and its resources. In Canada the Ocean Literacy group is represented by CaNOE, The Canadian Network for Ocean Education ([oceanliteracy.ca](http://oceanliteracy.ca)).

We are all connected with the ocean in diverse ways. Although we give names to different parts of the ocean, there is really only one ocean on Earth, and it covers over 75 percent of the planet. (Some have suggested the planet should be called Ocean rather than Earth.) Wherever we live, the ocean impacts us, and we impact the ocean.

There are a multitude of ways for students to learn about marine sciences, many different avenues of exploration and inquiry. This unit presents some ways in which students can become more ocean literate by exploring their connections with the ocean, and finding ways that we can learn from First Peoples' knowledge of the marine environment.

#### Essential Principles of Ocean Sciences

1. The Earth has one big ocean with many features.
2. The ocean and life in the ocean shape the features of the Earth.
3. The ocean is a major influence on weather and climate.
4. The ocean made Earth habitable.
5. The ocean supports a great diversity of life and ecosystems.
6. The ocean and humans are inextricably interconnected.
7. The ocean is largely unexplored.

Source: [www.oceanliteracy.net](http://www.oceanliteracy.net)



## First Peoples Connections

Coastal First Peoples' lives and cultures are inextricably connected to the ocean. Their survival has always depended on it. Through the traditional scientific knowledge acquired over generations, they understand its benefits, and also its stormy dangers. Many epic narratives connect with the ocean, including supernatural beings that live beneath the sea in parallel worlds to the humans.

First Peoples of BC's Interior also have a close connection to the ocean. The rivers that run through their territories all connect with the ocean. People of most regions of the interior cherish the salmon which migrates between the interior waterways and the ocean.

Harvesting foods from the marine ecosystem was one of the main features of the seasonal rounds of coastal peoples before contact. When industrialization arrived, many First Peoples from both the coast and the interior of the province participated in the commercial fishing industry. Usually the men fished the salmon and other fish, while women worked in the canneries. Today this economic activity is much reduced, which has had a great economic impact on coastal communities.

First Peoples have always monitored their environments to track changes. Continual observation of the local ecosystem is inherent in First Peoples' scientific practices. Today coastal First Nations communities work with scientists to monitor the well being of their oceans and lands using traditional knowledge and contemporary technology.

Many coastal First Nations communities have watchmen and stewardship projects that monitor important land and marine resources in their territories, as well as working to protect them.

First Peoples are concerned about current issues surrounding the well-being of the ocean, such as ship traffic and oil spills, over-fishing, fish farms and the effects of climate change. Many First Peoples are actively involved in scientific, ecological and political initiatives aimed at protecting the coast.

It's part of our culture, our history handed down from generation to generation. From my point of view, we're the original scientists. We're the original biologists, we're the original foresters, the original fishers.

Stan Dennis Jr, Lax Kw'alaams  
(*Eyes and Ears on the Land and Sea* video)





## PLANNING TO TEACH THE UNIT

These activities suggest some ways that students can connect marine sciences with local and Indigenous Knowledge. Teachers are encouraged to use some of the suggestions to incorporate ocean studies into their science curriculum.

### Outline of Activities

1. Connected to the Ocean
2. Knowing the Ocean
3. Monitoring the Ocean
4. Ocean Case Study: The Abalone Story
5. Ocean Case Study: Ocean Acidification and Hypoxia
6. Interconnectedness and Sustainability

Lu Lax Kyook Ecological Monitoring Project, Hartley Bay School, SD 52

### Enduring Understandings

- Coastal First Peoples' scientific understandings of the marine ecosystem have always enabled them to survive on and near the ocean.
- We are all connected to the ocean in many ways; we have a responsibility to protect it for the future.

### Essential Questions

- How can we apply First Peoples' scientific knowledge about the marine ecosystem to protect it in the future?
- In what ways are we all responsible for the well being of the ocean?

## Curriculum Connections

<b>Suggested Topics and Inquiry Questions</b>	<b>Learning Standards</b>
<b>Science 5</b>	
First Peoples’ understandings of structures and functions of marine organisms. <ul style="list-style-type: none"> <li>• How do First Peoples’ understandings affect harvesting practices?</li> <li>• How do they affect preserving methods?</li> </ul>	<i>Curricular Competencies</i> Choose appropriate data to collect to answer their questions Identify First Peoples’ perspectives and knowledge as sources of information
	<i>Content</i> Basic structures and functions of body systems: digestive, musculo-skeletal, respiratory, circulatory
Interconnectedness of humans and marine environment <ul style="list-style-type: none"> <li>• In what ways are we all connected to the ocean?</li> <li>• What can we learn from First Peoples’ traditional knowledge of the ocean?</li> </ul>	<i>Curricular Competencies</i> Demonstrate an understanding and appreciation of evidence Express and reflect on personal, shared, or others’ experiences of place
	<i>Content</i> First Peoples’ concepts of interconnectedness in the environment
First Peoples’ knowledge of sustainable practices <ul style="list-style-type: none"> <li>• How can we apply First Peoples’ understandings of sustainable use of the oceans?</li> </ul>	<i>Curricular Competencies</i> Identify some of the social, ethical, and environmental implications of the findings from their own and others’ investigations
	<i>Content</i> First Peoples’ knowledge of sustainable practices

<b>Science 6</b>	
<p>First Peoples’ understandings of body systems of marine organisms</p> <ul style="list-style-type: none"> <li>• How do their understandings affect harvesting practices?</li> <li>• How do they affect preserving methods?</li> </ul>	<p><i>Curricular Competencies</i></p> <p>Choose appropriate data to collect to answer their questions</p> <p>Identify First Peoples’ perspectives and knowledge as sources of information</p>
	<p><i>Content</i></p> <p>The basic structure and functions of body systems – excretory, reproductive, hormonal, nervous</p>
<p>Historical and current First Peoples’ use of separation and extraction methods of marine resources, such as oolichan oil.</p> <ul style="list-style-type: none"> <li>• How do First Peoples use their understanding of mixtures to make oolichan grease?</li> </ul>	<p><i>Curricular Competencies</i></p> <p>Identify questions to answer or problems to solve through scientific inquiry</p> <p>Transfer and apply learning to new situations</p>
	<p><i>Content</i></p> <p>Mixtures: Local First Peoples’ knowledge of separation and extraction methods</p>
<p>The importance of tides in coastal First Peoples’ cultures</p> <ul style="list-style-type: none"> <li>• How is First Peoples’ knowledge of the tides important for their survival?</li> </ul>	<p><i>Curricular Competencies</i></p> <p>Make observations in familiar or unfamiliar contexts</p> <p>Express and reflect on personal, shared, or others’ experiences of place</p>
	<p><i>Content</i></p> <p>Force of gravity</p> <p>The position, motion and components of our solar system in our galaxy</p>
<b>Science 7</b>	
<p>First People’s knowledge and use of marine organisms</p> <ul style="list-style-type: none"> <li>• How did/do First Peoples use their knowledge of marine organisms’ survival needs to modify the environment for harvesting? (eg clam gardens, herring roe on kelp)</li> </ul>	<p><i>Curricular Competencies</i></p> <p>Use scientific understandings to identify relationships and draw conclusions</p> <p>Express and reflect on a variety of experiences and perspectives of place</p>
	<p><i>Content</i></p> <p>Survival needs – all organisms need space, food, water and access to resources in order to survive</p>

<p>Local First Peoples’ knowledge of climate change</p> <ul style="list-style-type: none"> <li>• What can First Peoples’ traditional knowledge tell us about how climate change is affecting the marine environment?</li> <li>• How can we apply First Peoples’ knowledge to deal with the effects of climate change in the oceans?</li> </ul>	<p><i>Curricular Competencies</i>          Make observations aimed at identifying their own questions about the natural world          Apply First Peoples’ perspectives and knowledge, other ways of knowing, and local knowledge as sources of information</p> <hr/> <p><i>Content</i>          Evidence of climate change over geological time and the recent impacts of humans</p>
<b>Science 8</b>	
<p>First Peoples’ knowledge and use of marine organisms</p> <ul style="list-style-type: none"> <li>• How do changes in the ocean affect life processes of marine organisms, and in turn First Peoples who depend on them for food? (e.g acidification)</li> </ul>	<p><i>Curricular Competencies</i>          Formulate alternative “If...then...” hypotheses based on their questions          Use scientific understandings to identify relationships and draw conclusions          Transfer and apply learning to new situations</p> <hr/> <p><i>Content</i>          Characteristics of life – living things respire, grow, take in nutrients, produce waste, respond to stimuli, reproduce</p>
<b>Science 9</b>	
<p>Interconnectedness of marine systems with other spheres</p> <ul style="list-style-type: none"> <li>• In what ways are we all connected to the ocean?</li> <li>• What can we learn from First Peoples’ traditional knowledge of the ocean?</li> <li>• How can we apply First Peoples’ perspectives on interconnectedness for a sustainable future?</li> </ul>	<p><i>Curricular Competencies</i>          Apply First Peoples’ perspectives and knowledge, other ways of knowing, and local knowledge as sources of information          Contribute to finding solutions to problems at a local and/or global level through inquiry          Communicate scientific ideas, claims, information, and perhaps a suggested course of action, for a specific purpose and audience, constructing evidence-based arguments and using appropriate scientific language, conventions, and representations</p> <hr/> <p><i>Content</i>          First Peoples’ knowledge of interconnectedness and sustainability</p>



## Cross-Curricular Links

### SOCIAL STUDIES

A study of First Peoples' understanding of Ocean Sciences can be coordinated with Social Studies courses. Some applicable Content Learning Standards are:

SS 5:

- First Peoples land ownership and use

SS 6:

- Economic policies and resource management, including effects on Indigenous peoples

SS 7:

- Origins, core beliefs, narratives, practices, and influences of religions, including at least one indigenous to the Americas

SS 9:

- Physiographic features of Canada and geological processes: Perspectives on the use of natural resources

## Suggested Resources

- Blackline Master 8-1 Ocean Connections, page 189
- Ocean Literacy Guide. 13 page brochure which gives details on the 7 essential principles of Ocean Sciences. Download at <http://ow.ly/uCOQ302m1VR> or search from home page <http://oceanliteracy.wp2.coexploration.org/brochure/>
- Blackline Master 8-2 Marine Resources Used by Coastal First Peoples, page 190
- First Nations Traditional Foods Fact Sheets. See details in Additional Resources below
- Great Bear Sea videos and curriculum. A series of video clips based on the documentary *The Great Bear Sea: Reflecting on the Past—Planning for the Future*, and accompanying lessons. [www.greatbearsea.net](http://www.greatbearsea.net)
- Ocean Networks Canada website has a diversity of online monitoring and remote sensing activities, as well as many lessons for using them in the classroom. [www.oceannetworks.ca](http://www.oceannetworks.ca)



## Suggested Activities

### 1. CONNECTED TO THE OCEAN

Question for Inquiry: *How are we all connected to the ocean?*

We are all connected to the ocean in many ways, even if we do not live near it. Invite students to explore the ways that the ocean affects us and how we affect the ocean.

- a. Finding a physical connection. Wherever we are in BC (or anywhere else) we are on or near a watershed that ultimately connects to the ocean. In BC, most are connected to the Pacific, but the northeastern corner is connected to the Arctic Ocean.
  - Ask students to map their physical connections to the ocean. You may want to provide a map of BC, or challenge students to make their own sketch map.
  - Discuss ways that this physical connection might affect the ocean.
  - Find out if there is a storm drain marking program in your community. If there is, ask students to observe locations of marked storm drains. For more information, see the storm drain marking program website at: <http://ow.ly/tTwH302kjFg>.
- b. Blackline Master 8-1, Ocean Connections, may be used as an introductory activity or as a formative assessment activity.
  - As an introduction, students can brainstorm how the different items are connected to the ocean, and then do some research to find the connections.
  - Any reasonable suggestion is correct, but anticipated answers are:
    - a. every other breath: half of the oxygen we breath comes from the ocean.
    - b. fishing boat: oceans provide jobs.
    - c. ice cream: ice cream contains additives made from seaweed called carrigeenan.
    - d. syrup: syrups and other foods have ingredients made from seaweed called alginates.
    - e. freighter: the ocean is important for transportation; many of the goods we buy are shipped to us across the ocean.
    - f. fish for dinner: many foods we eat come from the ocean.
    - g. umbrella: the ocean has a big impact on our weather and climate.
  - One significant impact of the ocean not pictured here is the capacity of the ocean to store large amounts of carbon dioxide.
    - Challenge students to find a way to illustrate how the ocean stores carbon dioxide.

## UNIT 8 • OCEAN CONNECTIONS



- c. Why is the ocean important for life on Earth? Have students document the many ways that the ocean impacts life on earth.
- Begin with a class brainstorm activity, to see what students already understand about oceans.
  - Have students research a variety of resources, including print and online, to compile a list of “Ocean Facts and Figures.”
  - Have students find how many of the things we eat and use in the home are connected to the ocean. For example, many foods and products contain seaweeds.
    - Ask students to look at home for food and products containing carrageenan, algins, alginates, and agar.
- d. How do people affect the ocean? Ask students to document ways that human activity affects the ocean.
- Ask students to consider the ways we affect the ocean in terms of the four pillars of ocean health, as described by the Living Oceans Society: habitat, biodiversity, food webs and water quality.
    - Refer to the Society’s web site, <http://www.livingoceans.org>. Keyword search “living oceans four pillars.”
    - A short overview is given for each of the four pillars, including their importance and how humans interact with them. Students can develop specific examples of how we affect the ocean organized by these four pillars.
- e. Essential Principles of Ocean Sciences. Students may want to explore the essential principles for becoming an ocean-literate person. (See page 171.) These suggest many ways in which people are connected to the ocean. Refer to the website [www.oceanliteracy.net](http://www.oceanliteracy.net) for more information.
- Students can use the Ocean Literacy Guide to find more detailed information about each of the seven essential principles. They could work in groups to study an individual principle in depth and present findings to the class. The guide can be downloaded at [www.oceanliteracy.net](http://www.oceanliteracy.net).
  - For a more detailed outline of how the ocean and humans are interconnected, teachers and students may refer to the Ocean Literacy Scope and Sequence materials, particularly the Conceptual Flow Diagram for Principle #6. Diagrams have been developed for different grade levels: K-2; 3-5; 6-8 and 9-12. Direct link at <http://ow.ly/K8PR302kkKl>
- f. Ocean Connections Poster. Have students work individually or work in groups to create a visual representation of what they have learned about ways that the ocean affects us and how we affect it.
- This activity can be used as a formative assessment.





## UNIT 8 • OCEAN CONNECTIONS

### 2. KNOWING THE OCEAN

Question for Inquiry: *What can we learn from First Peoples' understanding of the ocean?*

First Peoples hold a wealth of Traditional Ecological Knowledge about the ocean, including an understanding of:

- tides and currents
  - biology and behaviour of marine plants and animals
  - harvesting techniques
  - using nature's signals to make predictions
  - preserving techniques
  - sustainability practices
- a. Students can develop their own inquiry questions to investigate one or more of these topics.
- Encourage students to incorporate wherever possible some aspects of Indigenous knowledge, such as:
    - Story: Find examples of traditional stories that connect with their inquiry topic.
    - Language: find words and phrases in the local First Nations language that relates to the topic.
    - Place names: where appropriate, connect traditional place names with the local marine ecosystems.
- b. Local Ocean Connections. If you live on or near the BC coast, discuss with students the importance of the ocean ecosystem to local First Nations communities.
- If possible, go on a beach walk with an Elder or knowledge keeper.
  - Invite an Elder or knowledge keeper into the class to speak about the connections to the ocean.
  - Students in communities away from the coast can find out links that the local First Nations have with the coast, both historically and currently.
    - For example, do they trade seafoods with Coastal First Nations?
    - Did or do people travel to the coast to participate in commercial fishing and canning?
  - Locate local traditional narratives that relate to the ocean.
    - See the Great Bear Sea video clip, “Respect” in which the Tsimshian story of Gitnagunaks is told. Youtube link at <http://bit.ly/2cBmQ0g>.
    - A similar version of the story is told in *Orca Chief* by Roy Henry Vickers.
- c. Have students investigate traditional knowledge and use of a marine plant or animal in depth, including its importance to the First Peoples cultures and survival.
- Blackline Master 8-2 has a list of a variety of marine plants and animals used by coastal First Peoples.





- Students can investigate the following aspects of a particular resource:
    - understanding of biology
    - harvesting techniques and precautions
    - preserving techniques
    - sustainability practices
  - If appropriate, students can interview family or community members, or Elders about their use of the marine resource under study.
  - Students might use the Blackline Masters from the Traditional Ecological Knowledge unit to help guide their research: Research Using the 7Es on page 50 and Traditional Ecological Knowledge Research, page 51.
- c. How do First Peoples’ understandings about marine organisms affect their harvesting practices? Students can demonstrate how traditional harvesting techniques employ specific scientific knowledge about a species.
- Student can illustrate the technological skills that are used or make models of the technology.
  - Some examples of topics are:
    - harvesting herring roe using hemlock or kelp gardens
    - stone fish traps built at the mouths of creeks
    - wooden fish traps built in estuaries (one good example is the Comox Harbour Fish Trap Complex.)
    - dentalia harvesting (A unique technology was developed to harvest this valuable deepwater shell. See “Money from the Sea” by Gloria Snivley. Details in Additional Resources below.)
    - halibut fishing
- d. Tides, currents and navigation. How is knowledge about the tides and currents important for survival?
- Students can investigate local knowledge of tides and ocean currents. Ideally they would interview Elders and knowledgeable community members about local conditions.
  - Locate traditional narratives that include tides and currents.

### 3. MONITORING THE OCEANS

Question for Inquiry: How do First Nations and scientists work together to monitor local marine ecosystems?

- a. Find out about watchmen and stewardship programs that coastal First Nations communities operate to monitor important land and marine resources in their territories, as well as working to protect them.
- Introduce the topic with the video *Eyes and Ears on the Land and Sea*.
    - This 12 minute video shows the purposes and activities of the Coastal Guardian Watchmen programs in communities of the North and Central Coasts.



## UNIT 8 • OCEAN CONNECTIONS

- Ask students to summarize the key points of the video, such as the goals of the Guardian Watchmen, and the types of monitoring activities they undertake.
  - Discuss the types of skills and training that Guardian Watchmen might need.
  - Find out more at the Coastal Guardian Watchmen website, <http://coastalguardianwatchmen.ca>
  - A longer video, *Keepers of the Coast* (38 min) focusses on how the Kitasoo/Xai'Xais, Heiltsuk, Nuxalk, and Wuikinuxv Nations of the Central Coast are stewarding their marine territories. Available at <https://vimeo.com/172824819>.
  - Find out if there is a local First Peoples monitoring and protection program near you. In some places, First Nations work together with other stakeholder groups to help monitor and manage local resources.
    - Some First Nations communities have biologists working with the community on monitoring and research programs.
    - Some communities operate salmon fish hatcheries under the Salmonid Enhancement program.
  - Invite a member of one of these programs to speak to the class, or if possible take a field trip to watch them in action.
    - Students can develop questions about the ways they use traditional knowledge in their jobs, what types of activities they do, and what training they have taken.
  - It may be possible for your students to be involved in a monitoring activity working with a local scientific team.
    - See the example of students from Hartley Bay School who worked with the Gitga'at Guardian Watchmen to help monitor a local estuary. The project is explained on page 187 below.
- b. Use Ocean Networks Canada activities to involve students in monitoring oceans. Ocean Networks is a scientific institution based at the University of Victoria that operates a number of remote monitoring observatories in the deep ocean off BC's coast. Many online tools are available at its website [www.oceannetworks.ca](http://www.oceannetworks.ca).
- Community Observatories. Ocean Networks also has several community observatories, most working with the local First Nations community. These include Kitamaat Village, Prince Rupert and Campbell River. Students can use online monitoring tools to see daily updates of a variety of weather and water quality data.
    - Access the community observatories by going to the “Learning” tab and selecting the “Ocean Sense” page. Direct link is <http://www.oceannetworks.ca/learning/ocean-sense>.
    - Use the “Community Observatories Section” links on the right side of



the page to access background information, links to the community observatories, and lesson ideas for how to use the monitoring data with students.

- Sights & Sounds. Follow the “Sights & Sounds” tab from the home page to experience a variety of images, sounds and video from the networks various remote sites. It includes live video of two deep sea sites.
  - Teaching Resources. Ocean Networks Canada has developed a number of lessons and lab activities for middle school and high school students. They can be found at the “Learning” tab under “For Educators” or use the link [www.oceannetworks.ca/learning/educators/teaching-resources](http://www.oceannetworks.ca/learning/educators/teaching-resources). Lessons dealing with monitoring include:
    - Ocean Observatories Lesson - Interpreting Data. Students explore how to use data and how to think critically about how data are used to reach conclusions. [www.oceannetworks.ca/interpreting-data](http://www.oceannetworks.ca/interpreting-data)
    - Camera Lesson - I See What You Did There. Students explore how cameras are used by researchers to better understand the deep ocean. Direct link at <http://bit.ly/2d5fymA>.
- c. Marine Planning. Students can investigate ways that First Peoples have participated in marine planning in their traditional territories, and how sharing traditional and local knowledge has helped the development of marine plans.
- What is marine planning? What are its purposes? Who is involved in marine planning?
  - View video clips from the Great Bear Sea project.
    - Protected Areas Overview. <http://bit.ly/2diNWZu>
    - Marine Planning - <http://bit.ly/2diNSZK>

#### 4. OCEANS CASE STUDY: THE ABALONE STORY

As a case study in issues around marine ecology and the impact of overfishing on First Peoples traditional foods, ask students to research the story of what has happened to the abalone in B.C.

Background: Abalone is a univalve mollusc whose meat is considered a delicacy. It has always been a part of the traditional foods of coastal First Peoples and often traded with interior peoples. Its shells are highly prized for use on masks and other carvings.

- Traditionally it is only harvested at extremely low tides. However with the advent of scuba diving gear, it could be taken at any time, and commercial harvesting seriously depleted the resource as a result.
  - Now it is illegal for anyone to harvest abalone in BC, even First Nations in their traditional waters.
- a. Introduce the topic by viewing the video *The Northern Abalone in Haida Gwaii*. 7.20 min. Haida Gwaii Stewardship Group. *The Northern Abalone in Haida*



## UNIT 8 • OCEAN CONNECTIONS

*Gwaii*. 7.20 min. <http://bit.ly/2deckcQ>

- This video gives a good introduction to the abalone and the issues surrounding it, and one First Nations' approach to restoration of abalone populations. It includes excellent underwater video of the abalone.
- b. Students can work collaboratively to investigate four main topics in the abalone story:
- Traditional harvesting and uses, including the shell
  - Overharvesting and depletion
  - Department of Fisheries and Oceans ban on harvesting; continued poaching; First Peoples deprived of an important resource
  - Attempts by First Nations and other partners to restore abalone populations
- c. Simulation game: The Northern Abalone: Species at Risk.
- Fisheries and Ocean Canada has developed lessons with a simulation game that demonstrates how overharvesting has led to the decline of abalone. It also includes sources for background information about the abalone.
  - The game and lessons are available at the Fisheries and Oceans website. Use the direct link <http://ow.ly/JfuO302AfXZ> or search keywords “dfo lessonplans abalone.”

### 5. OCEANS CASE STUDY: OCEAN ACIDIFICATION AND HYPOXIA

One of the major effects of climate change on oceans is ocean acidification (lowering of pH of oceans) and hypoxia (low oxygen levels).

- a. Students can develop inquiry questions around these topics to investigate the causes and effects of these changes in water properties. Particularly they can try to understand how acidification and hypoxia are affecting traditional foods harvested by First Peoples.
- Where possible, inquiries can incorporate field studies to the ocean, such as monitoring pH levels of nearby sites.
  - Acidification is a global issue. Students could compare the effects in BC with other places in the world, particularly at coral reefs.
  - One detailed source of information about ocean acidification can be found at the Coral Reef Information System website, [www.coris.noss.gov](http://www.coris.noss.gov). The FAQ sheet can be linked directly at <http://ow.ly/vWr3302AogP>
- b. Ocean Acidification lab activities. This topic gives opportunities for students to conduct laboratory activities in the area of chemistry.
- Challenge students to develop their own lab tests to demonstrate the effects of acidification on shellfish.
  - Some suggestions for hands-on experiments related to ocean acidification is found at the European Project on Ocean Acidification, [www.epoca-project.eu](http://www.epoca-project.eu). The direct link to the list of ideas is <http://ow.ly/UAd302Arpk>.

## UNIT 8 • OCEAN CONNECTIONS



- On-line activities can also be found at the Data in the Classroom site, [dataintheclassroom.noaa.gov](http://dataintheclassroom.noaa.gov). Direct link to a series of five activities at different levels using real data based in the Caribbean can be found at <http://ow.ly/zL8n302ArMz>.
- c. Hypoxia and the Oxygen Squeeze. This lesson developed by Ocean Networks Canada involves students in studying the role of dissolved oxygen in the marine environment, using data collected from oxygen optodes placed at remote sites.
- The lesson plan is available for download at <http://www.oceannetworks.ca/hypoxia-and-oxygen-squeeze>.

### Assessment

Here are some suggestions for assessing the Essential Questions of the unit. See general suggestions for assessment in the Introduction, page 24.

1. How can we apply First Peoples' scientific knowledge about the marine ecosystem to protect it in the future?
  - a. Ask students to take on the role of environmental scientists. Write a report that makes recommendations to the government utilizing First Peoples knowledge or sustainable practices in one area of protecting the marine ecosystem.
  - b. Have students draw an illustration of a part of a marine ecosystem, such as intertidal zone, open ocean or estuary, and label examples of First Peoples knowledge about sustainability.
2. In what ways are we all responsible for the well being of the ocean?
  - a. Ocean Connections Poster. Students summarize their understanding of ways that the ocean affects us and how we affect the ocean.

### Additional Resources

Claxton, Earl and John Elliot Sr. *Reef Net Technology of the Saltwater People*. Saanich Indian School Board. 1994.

History and cultural use of the reef net technology. Topics include origins, technology, ceremonies, and moons and tides.

*Eyes and Ears on the Land and Sea*. Coastal First Nations Great Bear Initiative. 2010. video 12 min. <https://vimeo.com/8317295>

An overview of the activities of the Guardian Watchmen programs in First Nations communities on the North and Central coasts.

*First Nations Traditional Foods Fact Sheets*. First Nations Health Authority. Copies may be ordered from the First Nations Health Authority, or downloaded at <http://bit.ly/2cUiFsl>.





## UNIT 8 • OCEAN CONNECTIONS

32 page brochure detailing many of the traditional foods from the land and sea, including harvesting methods and nutritional information.

*Keepers of the Coast.* Coastcast.ca Production. Central Coast Indigenous Resource Alliance. 38 min. [www.vimeo.com/172824819](http://www.vimeo.com/172824819)

Keepers of the Coast takes a close look at how the Kitasoo/Xai'Xais, Heiltsuk, Nuxalk, and Wuikinuxv Nations are stewarding their marine territories.

Kennedy, Dorothy and Randy Bouchard. *Sliammon Life, Sliammon Lands.* Vancouver: Talonbooks. 1983.

The cultures of the Homalco, Klahoose, Sliammon and Island Comox peoples. Includes traditional knowledge of marine ecosystems.

Klockars, Donna and Brenda Boreham. *Legends from the Chemainus Tribe. Stories and Teachings from the Oral Tradition of the Elders.* Chemainus Tribe and First Nations Education Services, SD 68 Nanaimo. 1992.

Cross-curricular lessons around two Chemainus stories, The Wolf Family Legend and Saved by the Orca. (The stories are published separately.) The "Saved by the Orca" unit includes the activities, Canoe and Paddlemaking and Clam Chowder.

McAllister, Ian and Nicholas Read. *The Great Bear Sea.* Orca Books. 2013.

Shows the marine ecosystems of BC North and Central coasts and issues facing the region, including climate change, overfishing, pipelines and oil tankers.

Menzies, Charles R. and Caroline F. Butler. "Returning to Selective Fishing through Indigenous Fisheries Knowledge." *The American Indian Quarterly* v 31, n 3. pp 441-464. 2007. Download at <http://ow.ly/pdQB302lWrU>.

This academic article suggests ways that sustainable traditional fishing techniques can be used today.

Pasco, Juanita. *The Living World. Plants and Animals of the Kwakwaka'wakw.* Alert Bay: U'mista Cultural Society. 1998

101 plants and animals used by the Kwakwaka'wakw, with pictures, descriptions and explanations of their importance.

Port Simpson Curriculum Committee. *Port Simpson Foods.* Prince Rupert, BC: People of Port Simpson and School District No. 52. 1983.

Information and activities about 60 different plants and animal resources traditionally used by the Tsimshian people. Includes line drawings of each species.

Snivley, Gloria. Money From the Sea: A cross-cultural Indigenous science problem-solving activity. *Green Teacher*, pp 33-39. 2009. Online at <http://bit.ly/2debjBJ>.

This article examines the sophisticated technology used to harvest the prized shell, dentalia.



## Lu Lax Kyook Ecological Monitoring Project Hartley Bay School, SD 52

Students from Hartley Bay School, of the Gitga'at First Nation, participated in real-life ecological monitoring of a local estuary over the 2014-2015 school year. They worked with Elders and scientists, and were supported by the community and the Band Council. Not only did they create their own learning, the students contributed real data to the communities on-going monitoring programs, and were able to help build a better capacity to plan for future generations. The project won the Jack Layton Award for Youth Action in Sustainability presented by Learning for a Sustainable Future for 2015. (See <http://lsf-1st.ca> for more information.)

View an overview of the project in this video: <http://bit.ly/2dqqVBc>

"We threw out the textbook and made our Place the textbook."

### *BACKGROUND*

Hartley Bay is the principal settlement of the Gitga'at First Nation, located 100 km south of Prince Rupert, at the mouth of Douglas Channel. They are members of the Ts'msyen Nation, and speak Sm'algyax. Hartley Bay Elementary/ Junior / Secondary School is part of Prince Rupert School District (52) with students from Kindergarten to Grade 12.

Like many First Nations, the Gitga'at have a Stewardship Program carried out by a team of trained community members called Watchmen. The Gitga'at Guardian Watchmen, among other activities, help to sustainably manage the lands, water and natural resources on Gitga'at traditional territory. This includes monitoring the marine resources within their traditional waters, which takes in part of the proposed oil tanker route from Kitimat. Some of the monitoring projects include bird surveys, intertidal biodiversity, hydrocarbon toxicity and sightings of marine mammals. This work is led by marine biologist Chris Picard, the Science Director for the Gitga'at.

### *PROJECT GOAL*

Our goal was to provide an immersive learning environment where no one subject area was distinct from the other. The students themselves, with the guidance and direction of teachers, would develop their own big ideas and construct their own knowledge. The process is generative from the place where the curriculum is formed. We threw out the textbook and made our Place the textbook.



## UNIT 8 • OCEAN CONNECTIONS

### PROJECT OVERVIEW

Place-based Participatory Action Research was the model used to design this learning project. We initially started with the students and asked them what they wanted to research and learn about. Concerns about tankers, understanding harvesting and issues around sovereignty came up; additionally, students wanted to get out into the territory to learn. Thus teacher Jeremy Janz and Hartley Bay School developed a cross-curricular course designed for the needs of both the Gitga'at and ministry requirements.

The initial part of this project incorporated both Socials, English and Media Visual Arts elements. Students interviewed elders about Traditional Ecological Knowledge which included harvesting sites, history, stories and methods. Mr. Janz's grade 6-8 class then created Language Arts reports which included both written and oral elements.

Once students had talked to the Elders and community, we connected with the Gitga'at Guardians to put their traditional knowledge to work with modern scientific techniques. The big goal here was to obtain baseline ecological data which serve as a tool for land claims and resource management. This progressed the goals of both the Gitga'at Band and the students. Thus students both learned and became participants in a community action project.

To conduct their surveys in the Mossy Bay estuary, students travelled by boats. The equipment and scientific instruments were in most cases supplied by the Gitga'at Guardians but the students were involved in making some instruments.

Students participated in monitoring five particular elements of the Lu lax kyook estuary:

1. Fish populations in the estuary (Beach Seining)
2. Salinity and Temperature
3. Stream Flow
4. Land Animals surveying (Trail Cameras)
5. Berries

Students used traditional techniques, for example, how to find an animal trail, and modern technology/science, for example, trail cameras. This created an excellent blend of the modern with the traditional. Additionally, students also learned in multiple subject areas through one learning project: Language Arts (Sm'algyax/English), Socials, Science, Math, PE, Media Visual Arts and Visual Arts.



## Ocean Connections

How are these things connected to the ocean?  
How do they show the importance of the ocean to everyone?



a. Every OTHER breath you take



b. Fishing boat



d. Syrup



c. Ice cream

No matter how far from the shore  
you live, the ocean still affects you!

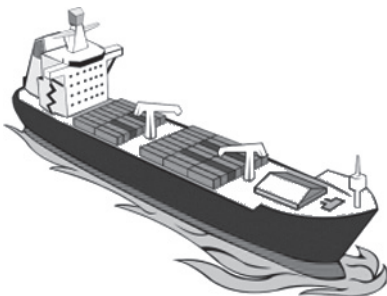

e. Freighter

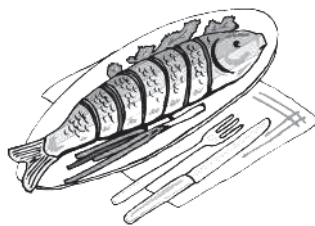

f. Fish for dinner



g. Do you need an umbrella today?

## MARINE RESOURCES USED BY COASTAL FIRST PEOPLES

### Plants, algae

eel grass  
seaweeds



### Invertebrates

abalone  
chiton  
clam  
cockle  
crab  
dentalia  
geoduck  
horse clam  
limpet  
mussel  
octopus  
prawn  
scallop  
sea cucumber  
sea urchin  
shrimp



### Fishes

cod  
dogfish  
eel  
flounder  
halibut  
herring  
oolachon  
salmon  
spotted ratfish  
rockfish



### Birds

duck  
geese  
seagull

### Mammals

fur seal  
harbour seal  
sea lion  
sea otter  
whale

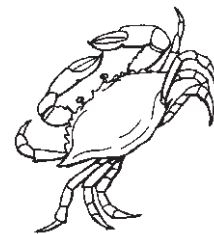

# ENCOURAGING FIRST NATIONS LEARNERS' ENGAGEMENT IN SCIENCE

It is important to remember that there is as much diversity between First Nations learners as there is among all learners in BC. What work for one learner may not work for all learners. However, there are some general strategies that can encourage more First Nations learners' interest and participation in the sciences.

- Emphasize experiential hands-on learning opportunities outside the classroom.
- Make room for students to explore aspects of science that they are interested in, and that are based in the learner's own curiosity.
- Provide opportunities for students to work with, and learn from, Aboriginal role models who work in the sciences, or Aboriginal post-secondary students in the sciences.
- Ensure that the learning in the classroom can be connected to the learner's knowledge outside the classroom.
- Honour that there is valuable knowledge in the sciences that is held by First Peoples (i.e. TEK).
- When in the classroom, ensure rich lab-work opportunities.
- Focus on the application of knowledge.
- Ensure visible presence of Aboriginal peoples/cultures in the classroom.
- Incorporate project-based learning that is connected to traditional Aboriginal seasonal practices (i.e. food-gathering or harvesting, hunting).
- Honour cultural knowledge of the students, and help them make "bridges" between different types of knowing.
- Model respect for Indigenous peoples and cultures.
- Create opportunities for students to engage in science clubs outside of the classroom. Hooking learners into the application of science may lead them to develop more interest in the theory.

In *Encouraging Aboriginal Students in the Sciences – Student Perspectives*, Ann Tenning interviewed Aboriginal students who were engaged in the sciences. The following excerpts illustrate their perspectives about what encouraged them to pursue a science path.

- "I like how there's so many experiments you can do and it's challenging, but in the end, you feel like you gave your best and you feel happy that you found the answer to what you were doing. It gives you a sense of pride or something."
- "Inclusion of Indigenous Knowledge in science education would give all students a wider perspective about science."

- Indigenous Knowledge in science “would be a good way to learn things, especially for Aboriginal students – they’d get more into it, instead of thinking, ‘oh, this is boring’ and they’d maybe want to explore more sciences if they were learning about their own people.” [A student] explained that Western Science is “contradictory to what you’re taught at home, so it’s just reinforcing that ‘living in two worlds’ kind of thing.”
- Participants reinforced the importance of teaching to a variety of different student-learning styles.
- Students need to be given ample opportunities to explore topics that are of interest to them.
- Students are more likely to develop a deeper interest in science if it is an interactive, hands-on, creative experience, rather than a passive experience which places an emphasis on rote methods of acquiring knowledge, including lectures, notes and memorization. Such methods of instruction are in stark contrast with traditional Indigenous ways of learning (which includes, but is not limited to, learning situated in a natural environment, experiential learning, and collaborative learning) and this may further alienate Aboriginal students who bring with them a strong sense of cultural connection.
- Indigenous Knowledge should be included at every level of science education. Indigenous content should be included in all science courses, particularly at the senior-secondary level, which are formative years for students as they transition into adulthood.
- Strengthen the link between K-12 science and post-secondary science areas and science-related careers.
- Aboriginal students need opportunities to see that science education can help to empower Aboriginal people and communities.

One way to engage students in science is to allow students to explore their own scientific curiosity through an in-depth inquiry. On the following pages is one model that can be used with students at any age level, the Shared Knowledge Science Celebration.

# SHARED KNOWLEDGE SCIENCE CELEBRATION

## PLANNING GUIDE

### What is a Shared Knowledge Science Celebration?

- Combination of a science fair and a learning expo
- Focuses on nature and “science topics related to Indigenous Knowledge”
- Inquiry driven
- Knowledge is gained through observation, Elders, knowledge keepers, literature
- Students follow the 7E format (environment, engage, explore, Elders, explain, elaborate, evaluate)
- Students demonstrate ongoing learning through a science story journal (visual journal)
- Continual reflecting and questioning to support the inquiry development
- Embed First Peoples Principles of Learning

### Rationale

- Directly related to the Learning Standards in the science curriculum
- Increase awareness of, interest in, and attention to science for Aboriginal students
- Demonstrate the interconnectedness of science practices in our world around us using both traditional and western science practices
- Provide an opportunity for educators to build skills sets in inquiry planning, and authentic Aboriginal perspectives within the curriculum
- Cross curricular
- Embed First Peoples Principles of Learning

### Goals (Ministry of Education)

The BC Science curriculum contributes to students’ development as educated citizens through the achievement of the following goals. Students are expected to develop:

- an understanding and appreciation of the nature of science as an evidence-based way of knowing the natural world that yields descriptions and explanations that are continually being improved within the context of our cultural values and ethics

- place-based knowledge and experiences about the natural world in the area in which they live by accessing and building on existing understandings, including those of local First Peoples
- a solid foundation of conceptual and procedural knowledge in biology, chemistry, physics, and earth and space sciences that they can use to interpret the natural world and apply to new problems, issues, and events, to further learning, and to their lives
- the habits of mind associated with science – a sustained curiosity; a valuing of questions; an openness to new ideas and consideration of alternatives; an appreciation of evidence; an awareness of assumptions and a questioning of given information; a healthy, informed skepticism; a seeking of patterns, connections, and understanding; and a consideration of social, ethical, and environmental implications
- a lifelong interest in science and the attitudes that will make them scientifically literate citizens who bring a scientific perspective, as appropriate, to social, moral, and ethical decisions and actions in their own lives, culture, and the environment.

Shared Knowledge uses the 7E model rather than the stages of scientific inquiry in the BC curriculum, but to the same end. This demonstrates to the students that there is no one set of stages for scientific inquiry.

Environment - everything is connected to everything

Engage (Purpose) – get excited

Explore (Hypothesis) – learn about something

Elder - Sharing and teaching traditional knowledge, connecting the science

Explain (Procedure) – tell how it is done

Elaborate (Observations) – share your knowledge

Evaluate (Conclusion) – what did you learn

## Using the 7E Model

### *ENVIRONMENT*

Students take the opportunity to learn traditional ecological knowledge (TEK) through place based activities. The traditional understanding that “everything is connected to everything” (Haida translation) takes a deeper appreciation when students are learning about the land and the environment in which they are situated. Students learned various “science stories” that would help them to ground their knowledge.

Example Activity: nature walk, discuss what the land may have looked like 500 years ago – what animals, plants and structures.

### *ENGAGE (PURPOSE)*

A shared knowledge inquiry project embeds within the practice the First Peoples Principles of Learning. Each week incorporates, builds upon and weaves through the practice a sense of responsibility, historical importance and connectedness. Students become engaged through the week 1 activities and begin to question, build curiosity and thread together ideas to solve big ideas. Students focus on one area of curiosity (we used the four elements to help guide students: earth, air, water, fire).

Example Activity: Element Mystery Bags: in a bag place objects that represent the four elements (earth, air, water, fire). Have students explore each element and create a brainstorm in their journal showing how they are all connected.

### *Explore (Hypothesis)*

Students began to explore their area of learning by creating a list of questions and connecting those questions to big ideas. With text resources, internet and interviews, students began to learn how their questions were related and formulate a “story of understanding” around the science.

Example: What plants grow here now? Where did the other plants go? Why are there some plants that are poisonous and some that you can make medicine from? How do plants help people, animals, and the earth?

Complete Blackline Master: Engage and Explore, page 202.

### *ELDERS*

Students worked side by side with experts, elders and cultural facilitators to develop models and greater understanding around their topic big idea. Big ideas were narrowed down to specific interests and knowledge was shared through traditional storytelling and hands on experiences.

Complete Blackline Master: Daily Knowledge Check, page 208.

### *EXPLAIN (PROCEDURE)*

Students begin to develop their own plan for creating an understanding of their specific interest. They journal the learning, record the steps to creating the model

Complete Blackline Master: Explain and Elaborate, page 203.

### *ELABORATE (OBSERVATION)*

Students create their models with the on-going support of the Elders and cultural facilitators. Using traditional practices they are able to generate examples of

scientific models and explain how they are connected to their questions and big ideas. A celebration for parents, guests and peers occurs where students are able to showcase their learning, share ideas and represent their learning. “Achievement Acknowledgements” are presented to each student.

Example Activities: Shared Knowledge Celebration where the school, community, elders and families are invited to listen, learn and engage in the knowledge as presented by the students.

### *WEEK 12 - EVALUATE (CONCLUSION)*

Assessment is a facet of all school learning. In traditional practices that can be demonstrated through the sharing of knowledge and the creation of hands on examples. To address the formative assessment throughout the learning, students complete a daily work reflection. That reflection acts like a running record of ideas continually being generated, plan making and knowledge accumulated. At the end of the celebration, students will complete a summative assessment reflection/ rubric to show how their learning changed and how they connected the traditional knowledge to their own “science story.”

Complete Blackline Master: Evaluate and Reflect, page 204.

### **Suggested Assessment**

- Use a science journal to have students record their daily learning, drawings, and formative assessment practices.
- Use the BC Science Fair guidelines for project evaluation ([www.sciencefairs.ca](http://www.sciencefairs.ca))
- Create a student Bingo search for sharing projects (Bingo Card Generator App) – students go around and answer the question that are posed on the bingo sheet– go for a full card (example attached)
- Formative assessment probes – to be used throughout student learning as a means to begin weekly journal reflections



## Sample Ideas for Shared Knowledge Topics

- Plants: traditional medicines (pick one and learn how it is made)
- Plants: Cedar - why doesn't stripping the cedar bark harm the tree?
- Why is eagle important?
- How do you make moccasins?
- Traditional fishing practices in the ocean, rivers or lakes
- What are plant indicators?
- What kinds of tools are made for wood carving?
- What does the button blanket represent?
- Why does a canoe float?
- What is the moon?
- What is the sun?
- How are stars used to navigate?
- What is the importance of games? (for example slahal)
- How do you make a drum have different sounds?
- There were no fridges, how is food preserved?
- What are crests?
- Tanning hides
- How are cedar baskets made waterproof?
- How is a longhouse built without hammer and nails?
- What was paint made from?
- Coast Salish weaving (wool)
- Patterns and graphics - math
- Where do we catch fish
- Baskets - purpose
- Pine needle baskets
- Medicine pouches
- Eagle feathers
- Seasonal rounds/cycles
- Music – does the material change the sound?
- Salmon
- Sustainable gathering/harvesting – how much is too much?
- Water – what does it tell you?
- Pit house construction
- Harvest rotations
- Animal connections
- Land formations and place names
- Temperature control in traditional houses (pit house, long house, tipi, etc.)
- Uses of obsidian
- How dyes are made and used

## **Samples of Learning Standards (Curricular Competencies) addressed through a Shared Knowledge Science Celebration in Grades 5-9:**

### *QUESTIONING AND PREDICTING:*

- Demonstrate a sustained curiosity about a scientific topic or problem of personal interest
- Make observations in familiar and unfamiliar contexts
- Make observations aimed at identifying their own questions about the natural world
- Identify a questions to answer or a problem to solve through scientific inquiry

### *PLANNING & CONDUCTING:*

- Explore and pose questions that lead to investigations
- With support, plan appropriate investigations to answer their questions or solve problems they have identified
- Collaboratively plan a range of investigation types, including field work and experiments, to answer questions or solve problems they have identified

### *PROCESSING AND ANALYZING DATA AND INFORMATION:*

- Experience and interpret the local environment
- Demonstrate an openness to new ideas and considerations of alternatives

### *EVALUATING:*

- Identify some of the social, ethical, and environmental implications of the findings from their own and others' investigations

### *APPLYING AND INNOVATING:*

- Contribute to care for self, others, and community through personal or collaborative approaches
- Co-operatively design projects
- Transfer and apply learning to new situations

### *COMMUNICATING:*

- Communicate ideas, explanations, and process in a variety of ways
- Express and reflect on personal, shared, or others' experience of place

## Snapshot of Cross Curricular Connections

### *LANGUAGE ARTS*

- Identify how story in First Peoples' cultures connects people to the land
- Exchange ideas and perspectives to build shared understanding
- Think critically, creatively, and reflectively to explore ideas within, between, and beyond texts
- Construct meaningful personal connections between self, text, and world

### *MATHEMATICS*

- Engage in problem-solving experiences that are connected to place, story, and cultural practices relevant to the local community
- Explore, apply, and connect concepts to each other, to other disciplines, and to the real world
- Implement multiple strategies to solve problems in both abstract and real life situations using different cultural perspectives

### *SOCIAL STUDIES*

- Use Social Studies inquiry process and skills to: ask questions; gather, interpret, and analyze ideas; and communicate findings and decisions
- Explain different perspectives on past or present people, places, issues, and events, and compare the values, worldviews, and beliefs of human cultures and societies in different times and places

## Sample Learning Framework

Mary started with a very basic topic. She wanted to know how a real pair of moccasins were made.

This is her brainstorm to help guide her science story:

- What are moccasins made of?
- Where does the leather come from?
- How is the leather processed?
- What are the different styles of moccasin?
- How are moccasins held together?
- What are moccasins used for?
- Who wears moccasins?
- Are there different kinds of moccasins?

ENVIRONMENT: Mary's class went on nature walks, saw videos and pictures and heard stories about the land around the school.

ENGAGE: Mary picked something that interested her from one of the four elements. Her topic is moccasins (earth).

EXPLORE: Mary then decided to explore something more specific about moccasins. She wanted to explore how moccasins were made.

This is a broad question to begin with. Mary will explore and do research and eventually narrow down her question even more by asking more questions.

How are moccasins made? They are sewn and decorated by hand using a variety of objects found in nature or through trade – bone needles, beads, dyes, fur. They are sewn with animal hide and sinew.

This leads to the question, “How is animal hide prepared so that it can be used to make moccasins?” In order to get the hide to make moccasins, Mary will need to find out that an animal is hunted, killed, skinned, and then how the hide is prepared through a process called tanning. There are different ways of tanning hide to make leather.

By doing research, Mary now has more questions to answer. What type of tanning produces the best leather for making moccasins? Why do different types of tanning produce different types of leather? Why are some waterproof and some not? What chemical change takes place when tanning leather? This last question requires Mary to look into the science behind making leather. She would then need to explain how leather is prepared for making moccasins.

ELDER: By connecting with an Elder, Mary is able to learn the process for preparing a hide. The Elder is teaching her through experiential practice, story and guided instruction. Traditional knowledge is being shared and Mary is learning and retelling the Elder what she understands.

EXPLAIN: Mary is now able to connect her learning from the Elder and apply the knowledge to her science story. She can retell the steps, demonstrate and answer questions about what is happening during the preparation of the hide and the creation of the moccasin.

ELABORATE: Mary would then need to elaborate on her findings. She would use a model to show her learning. She can tan a hide on her own in order to see what traditionally would have been done for thousands of years. Mary can also use technology to create a movie, power point, or story that explains her learning.

EVALUATE: Lastly, Mary needs to evaluate what she has learned, and share her knowledge. Mary will reflect on her learning, completing a reflection in her science journal.

## **Suggested Assessment**

Formative assessment probes

- How are moccasins connected to the element “earth”?
- Will tanning a hide to make moccasins change the feel of the leather?

## **Resources Used**

White, Kelli. Knowledge Sharing Fair: An Inquiry Approach to Integrating Indigenous Knowledge into the Science Curriculum Grade 4-8, Greater Saskatoon Catholic Schools, 2010

Manitoba First Nations Education Resource Centre Inc; Manitoba First Nations Science Fair, 2015

## Engage and Explore

ENGAGE (Purpose)

Pick a topic from one of the four elements of a science story.

Earth

Air

Water

Fire

EXPLORE (Hypothesis)

Using your topic, what question do you want to explore?

## **Explain & Elaborate**

EXPLAIN (Procedure)

What do you need to know to answer your question? Brainstorm all the details that will help you gain your knowledge.

ELABORATE (Observation)

Make a model to show your learning. What materials are needed? What are the steps in creating your model?

## Evaluate and Reflect

EVALUATE (Conclusion)

What is your science story? Use the following to help you reflect.

- Did you read books?
- Did you meet with a knowledge expert?
- Did you ask questions?
- Did your question change as you learned more?
- How did you share your knowledge? Why did you share your knowledge this way?
- What would you do differently next time?
- What questions do you still have?



## Evaluate and Reflect Self-Assessment

Student Name: \_\_\_\_\_ Shared Knowledge: \_\_\_\_\_

Check all boxes that support your learning. Answer the questions in the space provided.

### Shared Knowledge in the Environment

- I can make observations about the natural world.
  
- I can identify the four elements:
  1. \_\_\_\_\_
  2. \_\_\_\_\_
  3. \_\_\_\_\_
  4. \_\_\_\_\_
  
- I can experience and interpret the local environment using shared knowledge.

### Shared Knowledge Explorations

- I can identify questions from each of the four elements:
  1. \_\_\_\_\_
  2. \_\_\_\_\_
  3. \_\_\_\_\_
  4. \_\_\_\_\_
  
- I can explore and ask a specific question for my shared knowledge:  
\_\_\_\_\_

### **Shared Knowledge Explanations and Elaborations**

- I can listen to an elder/knowledge keeper to gather ideas for my shared knowledge.
- I can apply my shared knowledge to teach someone else.
- I can design a project, find information and create a shared knowledge science story for others.
- I can reflect and communicate my ideas in different ways:
  - Science story journal
  - Video
  - Display board
  - Model
  - Other: \_\_\_\_\_

- I can share Aboriginal understanding and teachings in my shared knowledge science story.

Explain how you can share Aboriginal understandings:

### **My new Shared Knowledge Science**

What are a few important things you learned about your topic during your shared knowledge learning?

What do you still wish you knew about your topic?

What could you do differently in your learning next time you participate in shared knowledge?

What did you enjoy the most about your shared knowledge science celebration experience?

## Shared Knowledge Science Celebration Survey

Please answer the following questions.

I enjoyed learning from a knowledge keeper. YES or NO

Why or Why not?

I learned about some Aboriginal traditions and the importance of respecting the land.

YES or NO

I learned a little bit about my own identity and beliefs. YES or NO

I learned that shared knowledge is a part of stories and can be passed down from family. YES or NO

I learned that Aboriginal knowledge is important to science. YES or NO

I learned that shared knowledge takes time and my own learning depends on my actions. YES or NO

I think that shared knowledge is important to family, the land and the history of Canada. YES or NO

In the space below, please tell us something you have learned about Aboriginal knowledge in science.

# SHARED KNOWLEDGE SCIENCE CELEBRATION

## DAILY KNOWLEDGE CHECK

### **Topic - Engaged - Purpose**

What is my topic I am engaged in learning?

---

### **Knowledge Finding - Explore - Hypothesis**

What did I learn today?

---

What do I still need to learn?

---

What do I still want to learn?

---

### **Knowledge Creating Explain - Procedure**

How can I explain my learning?

---

Is there a model I can make that shows my knowledge?

---

## **Knowledge Sharing - Elaborate - Observations**

How will I share my knowledge?

---

## **Knowledge Celebration - Evaluate - Conclusion**

Reflect on the learning you have done...

How will I use this knowledge and apply it to something new?

---

---

---

Draw a picture of what you have learned

A large empty rectangular box with a black border, intended for drawing a picture of what the student has learned.

## Shared Knowledge Science Celebration Bingo

Medicine was made of...	A female fox is called...	I read a traditional story about....	Another name for a longhouse is a ...
I know three names of shapes used in art	I learned how a dreamcatcher is made	Find one presentation from each of the four elements	A traditional story about a volcano is
Shared knowledge for all science stories begins with the e_____	The traditional story about the frog girl is ....	Shared knowledge is ...	Fire was started using...
A traditional story about the seasons is...	Animals are used for ...	A musical instrument can be made of ...	The animals and activities found in spring are

# Shared Knowledge Science Celebration Bingo Call List

This is a Bingo call list for the example on the previous page

A traditional First Nations story about the seasons is...

Medicine was made of ...

A traditional story about a volcano is...

A musical instrument can be made of...

The animals and activities found in spring are...

Find one presentation from each of the four elements

A female fox is called a...

I learned how a dreamcatcher is made.

Fire was started using...

I know three names of shapes used in art.

Shared knowledge for all science stories begins with the e\_\_\_\_\_

Animals are used for...

I read a traditional First Nations story about...

Shared knowledge is ...

Another name for a longhouse is a ...





# BIBLIOGRAPHY

This bibliography include resources listed in each of the units as well as supplementary resources. They are listed by category:

- Background Resources for Teachers
- Classroom Activities and Lessons
- Traditional Narratives
- Picture Books
- Student Print Resources
- Videos
- Websites and Multimedia

## Background Resources for Teachers

Aikenhead, G. and H. Michell. *Bridging Cultures: Indigenous and Scientific Ways of Knowing Nature*. Pearson Education, Don Mills, ON. 2012.

Examines Indigenous and Western science can be used together to build cross-cultural school science.

Bannister, Kelly Patricia. *Chemistry Rooted in Cultural Knowledge: Unearthing the Links Between Antimicrobial Properties and Traditional Knowledge In Food and Medicinal Plant Resources of the Secwepemc (Shuswap) Aboriginal Nation*. Thesis, UBC, July 2000. Online link at <http://bit.ly/2dyksEs>

Bonneau, Nancy. Shuswap and Okanagan First Nation Root Food Protocols. Masters Thesis, Simon Fraser University. 2003. Available online at <http://ow.ly/m0If302O93Y> or search on title keywords.

A study of the harvesting and protocols of two important plants, bitterroot and springbeauty. Contains excerpts of interviews with people who still harvest these plants today.

First Nations Pedagogy Online. <http://firstnationspedagogy.ca/>

This site provides best practices and support for online learning initiatives that are intended for aboriginal students, elders, educators, curriculum developers, and educational leaders.

Ignace, Marianne and Ignace, Ron. *The Secwepemc: Traditional Resource Use and Rights to Land in Native Peoples: The Canadian Experience*. Toronto: Oxford UP, 2004

Isaac, Irene. *Understanding Traditional Ecological Knowledge Through Kwakwaka'wakw Story*. Master's thesis, University of Victoria, 2010. Online at <http://bit.ly/2cCercS>

Description of a cross-cultural science and environmental education program using traditional Kwakwaka'wakw stories as a focus. Lessons were piloted in Alert Bay and evaluation showed

that the students understood the TEK of the people, and a range of western science concepts, and also respect of the people and the land.

Lee, Marc and Amanda Card. *A Green Industrial Revolution: Climate Justice, Green Jobs and Sustainable Production in Canada*.

[www.policyalternatives.ca/publications/reports/green-industrial-revolution](http://www.policyalternatives.ca/publications/reports/green-industrial-revolution)

A report on the industrial and employment strategies needed to transition to a sustainable economy and create a new generation of well-paying green jobs.

MacPherson, Nancy Elizabeth. *Traditional Knowledge for Health (Nlaka'pamux)* Masters thesis, UBC, 2009. <http://bit.ly/2dBfaM8>

This thesis studies the TEK of the Nlaka'pamux Nation as it relates to health.

Macchi, Mirjam. *Indigenous and Traditional Peoples and Climate Change*. 2008.

<http://bit.ly/2dKx3r0>

A global report on the response of Indigenous people around the world to climate change.

Menzies, Charles R. and Caroline F. Butler. "Returning to Selective Fishing through Indigenous Fisheries Knowledge." *The American Indian Quarterly* v 31, n 3. pp 441-464. 2007. Download at <http://ow.ly/pdQB302lWrU>.

This academic article suggests ways that sustainable traditional fishing techniques can be used today.

Michell, Dr. Herman, Yvonne Vizina, Camie Augustus and Jason Sawyer. *Learning Indigenous Science from Place*. University of Saskatchewan, 2008. Web at:

[portal.usask.ca/docs/Learningindigenousscience.pdf](http://portal.usask.ca/docs/Learningindigenousscience.pdf)

Research study examining Indigenous-Base Science perspectives in Saskatchewan First Nations and Métis Community contexts.

Turner, Nancy J. *Ancient Pathways, Ancestral Knowledge*. Volumes 1 and 2. McGill-Queen's University Press, 2014.

An extensive study of how knowledge of plants and environments has been applied and shared over centuries and millennia by Indigenous peoples.

Turner, Nancy J. "Not One Single Berry": Indigenous Knowledge and Environmental Change in British Columbia. <http://www.firstnations.de/media/06-4-1-turner.pdf>.

This article details how BC First Peoples traditional knowledge informs us about environmental change.

Turner, Nancy J. and Helen Clifton. "It's so different today": Climate change and Indigenous Lifeways in British Columbia. *Canada Global Environmental Change* 19 (2009). Available online at <http://bit.ly/2dj8hvY>

An academic article on Indigenous perspectives on climate change.

Turner, Nancy J., Marianne Boelscher Ignace, and Ronald Ignace. "Traditional Ecological Knowledge And Wisdom Of Aboriginal Peoples In British Columbia." *Ecological Applications* 10.5 (2000): 1275-287. Available online at <http://bit.ly/2cVwEOM> or search for title.

## Classroom Activities and Lessons

Aboriginal Education, Kamloops School District. *Science Resources*.

Elementary: <http://sd73aboriginaleducation.weebly.com/science.html>

Secondary: <http://sd73aboriginaleducation.weebly.com/science1.html>

These two lists provide many useful resources for the Secwepemc and many other First Nations.

Arntzen, Holly, Daphne Macnaughton, Briony Penn and Gloria Snively. *Salish Sea. A Handbook for Educators*. Victoria: Parks Canada 2001.

This resource guide combines music created by Holly Arntzen inspired by the Salish Sea, and related marine science activities for elementary students.

Bibby, Maureen and Teresa Laplante. *Ktunaxa Resource Kit Teachers Guide*. Ktunaxa/ Kinbasket Language Program. 1994.

These lesson activities include Plant Collecting, Hunting and Fishing, In Camp Activities and Transportation.

*Birchbark Canoes*. Dene Kede, Grade 8. Government of Northwest Territories. Link at <http://bit.ly/2d9Koq8>

These curriculum resources are from the Northwest Territories, but can be adapted for BC.

BC Climate Action Toolkit. <http://www.toolkit.bc.ca>

Website with suggestions for how to take action with classes locally.

Caduto, Michael and Joseph Bruchac. *Keepers of the Animals: Native American Stories and Wildlife Activities for Children*. 2013.

Caduto, Michael and Joseph Bruchac. *Keepers of Life: Discovering Plants through Native American Stories and Earth Activities for Children*. 2013.

Caduto, Michael and Joseph Bruchac. *Keepers of the Earth: Native American Stories and Environmental Activities for Children*. Fifth House, 1999.

Caduto, Michael and Joseph Bruchac. *Native American Gardening: Stories, Projects, and Recipes for Families*. 1996

Canadian Wildlife Federation. Strangers in a Strange Land. Link at <http://bit.ly/2d3RBw7>  
Online activities. Students explore the traditional wisdom of fishers, farmers, First Nations, and other peoples whose close relationship with nature gives them a deeper understanding of, and sensitivity toward, climatic cycles and events.

Clark, Karin. *First Nations in B.C.: Comparing Interior and Coastal Cultures*. Fifth edition. First Nations Education Division, Greater Victoria School District. 2002.

Teachers' resource guide with many activities for comparing interior and coastal First Nations. Specific topics on comparing environments, housing, transportation and clothing.

Climate Justice in BC: Lessons for Transformation. <http://www.teachclimatejustice.ca>

Curriculum package examines climate change and rising inequalities. Includes 8 modules with embedded videos, downloadable graphics, Power Points, print-friendly PDFs, and additional resources is available free to use and adapt.

Great Bear Sea videos and curriculum. A series of video clips based on the documentary *The Great Bear Sea: Reflecting on the Past—Planning for the Future*, and accompanying lessons. [www.greatbearsea.net](http://www.greatbearsea.net).

Klockars, Donna and Brenda Boreham. *Legends from the Chemainus Tribe. Stories and Teachings from the Oral Tradition of the Elders*. Chemainus Tribe and First Nations Education Services, SD 68 Nanaimo. 1992.

Cross-curricular lessons around two Chemainus stories, The Wolf Family Legen and Saved by the Orca. (The stores are published separately.) The "Saved by the Orca" unit includes the activities, Canoe and Paddlemaking and Clam Chowder.

Hammerman, Elizabeth. *Formative Assessment Strategies for Enhanced Learning in Science, K-8*. Thousand Oaks, California: Corwin Press. 2009.

Ignas, Veronica. *Two Ways of Knowing, Traditional Ecological Knowledge Meets Western Science*. 2003. <http://www.ecoknow.ca/curriculum.html>

Students compare Traditional Ecological Knowledge and Scientific Knowledge using case studies of Indigenous Plant Classification, the Pine Mushroom Industry in North West British Columbia, the Smallpox Epidemic of 1862 and the impact of AIDS today.

Ignas, Veronica. *Traditional Ecological Knowledge and Climate Change*. 2003. <http://www.ecoknow.ca/curriculum.html>

McKeen, Scott. *First Nations Resource Use on the Northwest Coast: Investigations into Geography, Ecology, Knowledge and Resource Management*. <http://www.ecoknow.ca/curriculum.html>

Students examine resource management and environmental issues, and ways that Traditional Ecological Knowledge can be used to address them. It features a resource management simulation.

Pacific Institute for Climate Solutions. Climate Insights 10.

<http://pics.uvic.ca/education>

Various teaching resources for the study of climate change.

Port Simpson Curriculum Committee. *Port Simpson Foods*. Prince Rupert, BC: People of Port Simpson and School District No. 52. 1983.

Information and activities about 60 different plants and animal resources traditionally used by the Tsimshian people. Includes line drawings of each species.

*Project Caribou. An Educator's Guide to Wild Caribou of North America*. Project Caribou.

Whitehorse: Government of the Yukon. 2001

A detailed guide to the caribou, including background information and activities. Includes BC caribou herds.

*The Salmon Bears Learning Guide*. Download at

<http://orcabook.com/greatbearbooks/teachers.html>.

A series of activities to use with the book *The Salmon Bears* in Life Science, Earth and Space Science and English Language Arts.

Sierra Club of BC. Education Learning Resource: Climate Change

<http://sierraclub.bc.ca/wp-content/uploads/2015/08/climate-change-learning-resource.pdf>

Snively, Gloria. *Beach Explorations. A Curriculum for Grades 5-10*. Oregon Sea Grant Program. 1998.

This resource includes a great variety of activities to do with beach studies, including suggestions for planning field trips to beaches, biological and ecological information and activities, science inquiries with specific types of seashore animals, and activities for different types of seashore habitats.

Snivley, Gloria. Money From the Sea: A cross-cultural Indigenous science problem-solving activity. *Green Teacher*, pp 33-39. 2009. Online at <http://bit.ly/2debjBJ>.

This article examines the sophisticated technology used to harvest the prized shell, dentalia.

Thompson, Judy. *Traditional Plant Knowledge of the Tsimshian*. 2003.

<http://www.ecoknow.ca/curriculum.html>

Students apply understandings of Traditional Ecological Knowledge to plant identification, classification, traditional cultural practices and nutrition.

Van Tol, Alex. *Nowhere Else on Earth Teachers' Guide*. Download at <http://orcabook.com/nowhereelseonearth/teachers.html>.

Lesson activities to accompany *Nowhere Else on Earth*, includes bears, salmon, Great Bear Rainforest, and First Nations interactions.

Aboriginal Curriculum Integration Project, SD 79 Cowichan Valley. <http://bit.ly/2dkCSaG>  
Environmental Lessons for Grades 7-9.

Walker, Donna. *First Nations Science & Ethnobotany Unit K-10*. Vancouver Island Region for Aboriginal Education. N.d.

15 activity cards with science and art activities including these plants: salal, miner's lettuce, cow parsnip, salmonberry, sweet camas, red laver, chanterelle mushroom, sphagnum moss, ferns, white fawn lily, lodgepole pine and red cedar, red alder, kinnikinnick, eel grass and oregon grape, cat tails.

Lesson topics: Berries (K-7); Characteristics of Plants (K-1); Science Ecology - technology & resource use (8); Life Sciences -fishing technology; Medicinal plants (Sitka spruce, stinging nettles); Plant Identification (ethnobotany field trip); seasons (primary); simple machines and raising a post.

Wright, John and Duane Johnson. *Indigenous Knowledge and Cultural Weather Perspectives: Lessons to Support Science 10*. Saskatchewan Teachers Federation. 2007. Online at <http://bit.ly/2czWJ4E> or search on title keywords.

These lessons examine cultural perspectives on weather and weather predictions. Based on Saskatchewan First Peoples, but may be adapted for BC.

## Traditional Narratives

*Ch'askin*. Sechelt Nation. Gibsons, Nightwood Editions, 2003.

This traditional Sechelt story illustrates the power of Ch'askin, the Thunderbird.

Boreham, Brenda. *Saved by the Orca = Q'ulhnumtthan : a story from the oral tradition of the Chemainus elders*. Gabriola, B.C. : Pacific Edge Publishing and Media Services. 1992.

*Coyote and the Sun and Other Stories*. Secwepemc Cultural Education Society, Kamloops BC. 1993.

*The Gift of the Bitterroot*. As told by Johnny Arlee. Npustin Press, Salish Kootenai College. 2008. A PDF version is available at the Lessons of Our Land website, <http://www.lessonsofourland.org>. The direct link is <http://ow.ly/vZ4J302OYM9>.

This picture book includes a traditional narrative of the Salish and Pend d'Oreille First Peoples from Montana, relatives of their Canadian neighbours who also prize the bitterroot. It explains the origins of the bitterroot.

*Kou-Skelowh / We are the People*. Theytus Books, 1999.

Contains three Okanagan traditional narratives: How Food was Given (Led by Grizzly Bear, the plants and animals promise to sacrifice themselves to provide food for humans); How Names were Given (Animals are given roles before the arrival of humans) and How Turtle Set the Animals Free (Turtle outsmarts Eagle to free the animals).



Ktunaxa Nation Creation Story. Ktunaxa Nation website.

<http://www.ktunaxa.org/who-we-are/creation-story/>

In preparation for the arrival of humans, the animals chase a terrible monster through the Ktunaxa territory. The story of the chase names places throughout the region. Events following the defeat of the monster end up creating physical features, including the Rocky Mountains.

Nisga'a Lisims Government. *Volcano*. <http://www.nisgaanation.ca/volcano>

This website gives a version of the traditional story about the Nass valley volcano.

Sechelt Nation. *Mayuk the Grizzly Bear*. Gibsons, Nightwood Editions. 1993.

A Sechelt Elder tells a traditional narrative when he gives a name to his great grandson. Two brothers rescue their younger brother from a grizzly bear that they wounded when they were hunting. The baby is not named after the brave hunters, but after the respected foe, Mayuk the grizzly. Contains elements of TEK, such as knowledge of bears' anatomy and use of medicinal plant.

Stó:lō Nation and The Reach Gallery Museum, Abbotsford. *Man Turned to Stone* website. Link at <http://bit.ly/2dxcNGI>

Describes the traditional story of the man who was transformed to stone, as well as a background to the importance of stories and the connections with the land.

Tsimshian Nation. *Luutigm Hoon – Honouring the Salmon : An Anthology Told in the Voices of the Tsimshian*. Prince Rupert, B.C. : Tsimshian Nation, School District 52 (Prince Rupert). 1999.

Includes traditional stories “The Adawx of the Salmon and the Prince” and “The Origin of Fishing Nets.”

Vickers, Roy Henry. *Orca Chief*. Madeira Park BC: Harbour Publishing. 2015.

When four hunters from Kitkatla arrive at their fishing grounds, exhaustion makes them lazy and they throw their anchor overboard without care for the damage it might do to marine life or the sea floor. When Orca Chief discovers what the hunters have done, he sends his most powerful orca warriors to bring the men and their boat to his house. The men beg forgiveness for their ignorance and lack of respect, and Orca Chief compassionately sends them out with his pod to show them how to sustainably harvest the ocean's resources.

White, Ellen Rice (Kwulasulwut). *Legends and Teachings of Xee'x, The Creator*. Pacific Educational Press, 2006.

Four traditional narratives presented for high schools students. Includes The Creator and the Flea Lady which includes the theme of interconnectedness.

*People of the Land : Legends of the Four Host First Nations*. Theytus Books. 2009.

Narratives of the Lil'wat, Musqueam, Squamish and Tsleil-Waututh First Nations published in connection with the 2012 Vancouver-Whistler Olympics.

Many photographs illustrate this anthology of the Lil'wat, Musqueam, Squamish and Tsleil-Waututh First Nations traditional stories. These stories link people to the land and to each other and pass on traditional knowledge and history. These sacred teachings – which range from creation stories to naming stories – are collected in an anthology of stories shared by storytellers of each nation. The book celebrates the four host First Nations on whose ancestral territories the Vancouver 2010 Olympic and Paralympic Winter Games were held.

## Picture Books

Armstrong, J. *Enwhisteetkwa Walk in Water*. Theytus, 1986.

Helin, Bill. *Making a Canoe*. Strong Stories series. Strong Nations Publishing, 2016.

A short picture book by Tsimshian artists Bill Helin that describes the steps in making a cedar canoe.

McAllister, Ian. *The Salmon Bears: Giants of the Great Bear Rainforest*. Orca Books, 2010.

Explores the delicate balance that exists between the grizzly, black and spirit bears that inhabit the last great wilderness along the central coast of British Columbia and their natural environment.

McLeod, Elaine. *Lessons from Mother Earth*. Groundwood, 2002.

Tess learns from her grandmother that her garden is all of nature. As they pick plants and berries, they do so carefully and with respect. Tess discovers that if she cares for the Earth, it will provide for her just as it provided for generations past. The story could make an excellent introduction to an ecology unit that could be used to support a discussion about the interdependence and interconnectedness between humans and their natural environment.

Reid-Stevens, Amanda. *The Canoe He Called Loo Taas*. Benjamin Brown Books, 2010.

A picture book about Haida artist Bill Reid building the canoe named Loo Taas.

Sellars, Willie. *Dipnetting with Dad*. Caitlin Press. 2014

A boy learns much about his Secwepemc culture through activities with his father, focusing on the dipnetting for salmon. Themes include family values, storytelling, traditional ecological knowledge and coming of age. The author is a member of the Williams Lake Indian Band.



## Student Print Resources

André, Julie-Ann and Mindy Willett. *We Feel Good Out Here*. Fifth House, 2008.

An illustrated account of how the author and her family connect with the land in Gwich'in territory in the Northwest Territories.

Bridge, Karen and Kevin Neary. *Voices of the Elders. Huu-ay-aht Histories and Legends*. Heritage House, 2013.

A history of the Huu-ay-aht people of the west coast of Vancouver Island, including chapters on the traditions about the Great Flood and earthquakes.

Brown, F. and Y. K. Brown (compilers). *Staying the Course, Staying Alive – Coastal First Nations Fundamental Truths: Biodiversity, Stewardship and Sustainability*. Biodiversity BC. Victoria BC 2009. Download at [www.biodiversitybc.org](http://www.biodiversitybc.org) or link directly at <http://ow.ly/LV5X302mlHN>

Through examples from Heiltsuk, Namgis and Haida First Peoples, this book discusses seven Fundamental Truths shared by most BC First Nations: Creation; Connection to Nature; Respect; Knowledge; Stewardship; Sharing; and Adapting to Change. Includes many examples from traditional stories and teachings.

Claxton, Earl and John Elliot Sr. *Reef Net Technology of the Saltwater People*. Saanich Indian School Board. 1994.

History and cultural use of the reef net technology. Topics include origins, technology, ceremonies, and moons and tides.

Coull, Cheryl. *A Traveller's Guide to Aboriginal BC*. Whitecap Books, 1996.

An overview of all First Nations communities in BC, with local information, including tribal and community names, and significant cultural features.

Evans, Doug. *Noah's Last Canoe: The Lost Art of Cree Birch Bark Canoe Building*. Winnipeg: Great Plains Publications. 2008.

The construction of a birch bark canoe in Pelican Narrows, Saskatchewan by Cree Elder Noah Custer is document through text and photographs.

Finkbeiner, Ann. The Great Quake and the Great Drowning. *Hakai Magazine*. 2015. Online at [www.hakaimagazine.com/article-long/great-quake-and-great-drowning](http://www.hakaimagazine.com/article-long/great-quake-and-great-drowning) [search title keywords]

This article discusses the Cascadia quake of 1700 and similar events in Indigenous oral history on the coast of BC and the US, and how they are viewed today.

*First Nations Traditional Foods Fact Sheets*. First Nations Health Authority. Copies may be ordered from the First Nations Health Authority, or downloaded at [http://www.fnha.ca/Documents/Traditional\\_Food\\_Fact\\_Sheets.pdf](http://www.fnha.ca/Documents/Traditional_Food_Fact_Sheets.pdf)

32 page brochure detailing many of the traditional foods from the land and sea, including harvesting methods and nutritional information.

First Peoples of BC, Map. [www.bced.gov.bc.ca/abed/images/map2.jpg](http://www.bced.gov.bc.ca/abed/images/map2.jpg)

Gina 'Waadluxan Tluu / *The Everything Canoe*. Skidegate: Haida Gwaii Museum Press, 2010.

An extensive look at the canoe in Haida culture, with many illustrations and photos.

Groesbeck AS, Rowell K, Lepofsky D, Salomon AK. "Ancient Clam Gardens Increased Shellfish Production: Adaptive Strategies from the Past Can Inform Food Security Today." *PLoS ONE* 9(3): e91235. 2014. Online link at <http://bit.ly/2dkznAU>. Search the keywords "Ancient Clam Gardens PLOS"

A scientific article describing a study of clam gardens on BC coast that can be downloaded.

Hare, Tony. *Animal Fact File : head-to-tail profiles of more than 90 mammals*. Facts on File, 1999.

This work covers 90 warm-blooded animals from around the world, each animal on a two-page, full-colour illustrated spread that shows the entire mammal and highlights interesting parts of its anatomy. Good source for bear anatomy if available.

Jennings, John. *The Canoe, a Living Tradition*. Firefly 2002.

A history of the construction and use of the canoe, kayak, dugout and umiak in North America.

Kennedy, Dorothy and Randy Bouchard. *Sliammon Life, Sliammon Lands*. Vancouver: Talonbooks. 1983.

The cultures of the Homalco, Klahoose, Sliammon and Island Comox peoples. It includes information about harvesting practices, such as fishing, gathering shellfish, sea and land mammal hunting, bird hunting and plant foods. Also includes some traditional narratives.

Kirk, Ruth. *Wisdom of the Elders. Native Traditions on the Northwest Coast*. Douglas & McIntyre 1986.

This book is about the cultures of the Nuu-chah-nulth, Kwakwaka'wakw and Nuxalk peoples. Some of the relevant content includes: Houses, p105-108; Tools 112-113; Canoes, 115-118.

Ludwin, Ruth S. *Searching for Native Stories about Cascadia Subduction Zone Earthquakes*. <http://ow.ly/TSGB303sTyd>

A poster in pdf format about the connections between First Nations' oral histories with Cascadia Subduction zone earthquakes

Ludwin, Ruth S. et al. Dating the 1700 Cascadia Earthquake: Great Coastal Earthquakes in Native Stories. *Seismological Research Letters* Vol 76, no. 2. March/April 2005. Available online at <http://ow.ly/nRdU303sTj5>

McAllister, Ian and Nicholas Read. *The Great Bear Sea*. Orca Books. 2013.

This lavishly illustrated book shows the marine ecosystems of BC North and Central coasts. It also explores issues facing the region, including climate change, overfishing, pipelines and oil tankers.

Marshall, Amanda L. *Culturally Modified Trees of the Nechako Plateau: Cambium Utilization Amongst Traditional Carrier (Dakhel) Peoples*. M.Sc. Thesis, Simon Fraser University. 2002. Link at <http://bit.ly/2d6I1bQ> or search on keywords Nechako plateau Marshall.

This study combines oral histories with archaeological data of CMTs in the Dakhel traditional territories. Includes ten transcripts of Dakelh elders discussing traditional uses of inner bark as a food resource. They also encompass other aspects of TEK. Chapters on the study of CMTs may also be useful.

Nabokov, Peter and Robert Easton. *Native American Architecture*. Oxford University Press, 1989. A detailed examination of the architecture of First Nations house architecture across North America.

*Nak'azdli Elders Speak : Nak'azdli t'enne Yahulduk*. Penticton: Theytus Books 2001.

These reminiscences of seven elders from the Dakelh community of Nak'adli include traditional stories, history, cultural practices and traditional ecological knowledge.

Neel, David. *The Great Canoes: Reviving a Northwest Coast Tradition*. Douglas & McIntyre 1995.

This book includes 70 photos with words from elders, builders, paddlers, chiefs and young people, documenting the canoe gatherings of the 1990s.

*Northwest Coast Canoes*.

[https://www.sfu.ca/brc/art\\_architecture/canoes.html](https://www.sfu.ca/brc/art_architecture/canoes.html)

This web site from the Bill Reid Centre details all aspects of making the Northwest coast canoe.

Parish, Roberta. *Tree Book: Learning to Recognize Trees of British Columbia*. Partnership Agreement on Forest Resource Development. Print version, or download online at <http://ow.ly/7DLO302Wa1h>

This book details 40 trees native to BC. It included an identification key and information about each tree, including its habitat and First Nations uses.

Pasco, Juanita. *The Living World. Plants and Animals of the Kwakwaka'wakw*. Alert Bay: U'mista Cultural Society. 1998

101 plants and animals used by the Kwakwaka'wakw, with pictures, descriptions and explanations of their importance.

*River of Salmon Peoples*. Theytus Books, 2015.

Memories, stories and voices of First Peoples living in the Fraser River watershed, including Musqueam, Lil'wat7ul Mount Currie, Secwepemc, Nl'kepmxcinm, Dakelh & Tsilhqot'in, Sardis Stó:Lō and Seabird Island Stó:Lō communities. Includes text and photographs organized in five chapters: 1. The Fraser River as a Unifying Form; 2. The Fraser River as an Expression of Diversity; 3. The Fraser River as History of Change; 4. The Fraser River as a Spiritual and Cultural Relationship; 5. The Fraser River as a Place of Hope and Reconciliation.

Stewart, Hilary. *Drink in the Wild : Teas, Cordials, Jams and More*. Vancouver: Douglas & McIntyre, 2003.

This book gives clear instructions on how to prepare teas using many plants found in BC.

Stewart, Hilary. *Stone, Bone, Antler and Shell. Artifacts of the Northwest Coast*. Douglas & McIntyre, 1996.

Detailed study of the many ways that stone, bone and other materials were and are used by BC First Nations. Includes many diagrams and illustrations.

Stewart, Hilary. *Cedar: Tree of Life to the Northwest Coast Indians*. Vancouver, B.C.: Douglas & McIntyre, 1984.

Detailed study of the many ways that cedar is used by BC First Nations. Includes many diagrams and illustrations.

Turner, Nancy J. *Food Plants of Coastal First Peoples*. Royal British Columbia Museum Handbook series. UBC Press. 1995.

Turner, Nancy J. *Food Plants of Interior First Peoples*. Royal British Columbia Museum Handbook series. UBC Press. 1997.

Turner, Nancy J. *Plant Technology of First Peoples in British Columbia*. Royal British Columbia Museum Handbook series. UBC Press. 1998.

Turner, Nancy J. *Plants of Haida Gwaii*. Winlaw, B.C: Sono Nis Press. 2005.

Turner, Nancy J. and Richard Hebda. *Saanich Ethnobotany: Culturally Important Plants of the WSÁNEĆ People*. Royal BC Museum, Victoria, BC. 2012.

Turner, Nancy J. *The Earth's Blanket, Traditional Teachings for Sustainable Living*. 2014.

Turner, Nancy J. *Ethnobotany and Ecological Wisdom of Indigenous Peoples of Northwestern North America*. Volumes 1 and 2. 2014.

Turner, Nancy J. "Not One Single Berry": Indigenous Knowledge and Environmental Change in British Columbia. <http://bit.ly/2dzwQEk>.

Vernon, Caitlyn. *Nowhere Else on Earth: Standing Tall for the Great Bear Rainforest*.

Filled with history, biology, geography, ecology, environmental studies, personal anecdotes, pictures, and activities about the Great Bear Rainforest.

Warner, Graham and David Gidmark. *Canoe Paddles, a complete guide to making your own*. Firefly 2001.

A comprehensive guide to the history and construction of paddles, including many Indigenous examples.

Williams, Judith. *Clam Gardens*. New Star Books, Vancouver. 2006.

One of the first studies to examine the management of clam beds by coastal First Nations.

## Videos

*Aboriginal Culture in British Columbia*. 2011 4:32 min. Link at <http://bit.ly/2dCTa2L>

This is a BC Tourism promotional video that might be used as an introduction to the diversity of technologies and cultures of BC First Nations.

*Art As Culture*. Kyran Yeomans. 2012. 22 min. <https://vimeo.com/71288680>

Haida artist Kyran Yeomans directs and narrates this film which documents his father Don Yeoman's creation of a totem pole for the McMichael Art Gallery in Ontario. It has a youthful humorous style and may lead to a useful discussion about traditional and contemporary technology. Both power and traditional hand tools are used. The pole itself incorporates electronic technology, with one of the figures listening to an iPod and another using a laptop.

*Bear Witness*. Central Coast First Nations Bear Working Group. 2013. 22 minutes. On Youtube, link at <http://bit.ly/2cjDHBm> or the website [www.bearsforever.ca](http://www.bearsforever.ca)

This video takes a compelling look at the issue of trophy hunting of grizzly bears on BC's Central Coast, while illustrating the relationships of people and bears and the connections First Nations have with the bears and the land. It also shows a strong relationship between First Nations guardians and scientists who share research into bear populations. NOTE: This video includes a number of short but graphic clips of dead bears and bear parts. Preview to make sure it is appropriate for your students.

*Eyes and Ears on the Land and Sea*. Coastal First Nations Great Bear Initiative. 2010. video 12 min. <https://vimeo.com/8317295>

An overview of the activities of the Guardian Watchmen programs in First Nations communities on the North and Central coasts.

Great Bear Sea videos and curriculum. A series of video clips based on the documentary *The Great Bear Sea: Reflecting on the Past—Planning for the Future*, and accompanying lessons. Access youtube playlist at <http://bit.ly/2d9yKNB> or visit website [www.greatbearsea.net](http://www.greatbearsea.net).

*Gwaii Haanas Legacy Pole*. Youtube video at <http://bit.ly/2dFmN0I>

This pole includes crest figures commemorating the 2012 earthquake that hit Haida Gwaii. The artist explains the crests carved on the pole:

Haida Gwaii Stewardship Group. *The Northern Abalone in Haida Gwaii*. 7.20 min.

<http://bit.ly/2deckcQ>

This video gives a good introduction to the abalone and the issues surrounding it, and one First Nations' approach to restoration of abalone populations. It includes excellent underwater video of the abalone.

Heath, Joel and the Community of Sanikiluaq. *People of a Feather*. Video. 1 h 32 min.

Documentary film about survival in a changing Canadian Arctic. Available on disk or rental through Vimeo.

*Hul'q'umi'num' stories: thulqushunum' | Rainbow*. Hul'q'umi'num' Language and Culture Collective. 2015. 3:10 min. <https://vimeo.com/132893949>.

Jordana Seymour and Donald White are canoe pullers in the Rainbow canoe club, Stz'uminus, BC. Delores Louie translates their story into Hul'q'umi'num'. Narration in Hul'q'umi'num' with Hul'q'umi'num' and English text.

*Keepers of the Coast*. Coastcast.ca Production. Central Coast Indigenous Resource Alliance. 38 min. [www.vimeo.com/172824819](http://www.vimeo.com/172824819)

Keepers of the Coast takes a close look at how the Kitasoo/Xai'Xais, Heiltsuk, Nuxalk, and Wuikinuxv Nations are stewarding their marine territories.

*Meet Coyote, an Aboriginal "Legend."* Aboriginal Tourism BC. 2015. 2:34. Youtube link at <http://bit.ly/2drCEPJ>

Coyote the Trickster in Interior BC First Nations cultures. Includes Coyote Markers, balancing rock monuments that mark territorial boundaries.

*Meet a Local Legend: K'umugwe Dancers*. Aboriginal Tourism BC. 2015. 3:50. Youtube link at <http://bit.ly/2cjDsGt>

A 13 year old dancers shows his connection with his culture and the land, and performs a traditional dance in a bear costume. "I'm wearing a mask that is from a tree that is from hundreds of years ago. The fire is our connection with our ancestors."

*Meet a Local Legend: The Salmon*. Aboriginal Tourism BC. Link at <http://bit.ly/2cL0JTg>

Elder Ralph Phillips of the Xat'sull First Nation talks about how the fish has sustained First Nations communities since time immemorial/

*Northwest Coast Native Paddle Making*. 2012. 8:18 min. <http://bit.ly/2drhIgg>

Coast Salish carver Sean Peterson of the Puyallup tribe demonstrates contemporary process of carving a paddle, using hand and power tools.

Peterson, Shaun. *Adzes and Knives*. 2008. <http://bit.ly/2cL1LyD>

Puyallup/Tulalip carver Peterson describes his carving tools in this personal video.



*Spirit Canoe in Slow Motion*. 2012. 1:41 min. <http://bit.ly/2drj7nf>

A short video taken from the bow showing pullers paddling in time on the last day of 2012 Pulling Together Canoe Journey, SD 46 Sunshine Coast.

*Through Arctic Eyes*. 3 minute video. <http://bit.ly/2cSLeGB>

Impacts of climate change in First Peoples' communities in Yukon and Alaska.

## Websites and Multimedia

*Canoe Designs of the Pacific Northwest*. <http://www.donsmaps.com/canoedesigns.html>

A useful web site that illustrates many types of canoes used traditionally in BC.

*Connecting Traditions*. Secwepemc Nation. <http://secwepemc.sd73.bc.ca/>

This interactive multimedia presentation gives cultural information about the Secwepemc people.

*First Voices*. <http://www.firstvoices.com>

Web-based tools and services designed to support Aboriginal people engaged in language archiving, language teaching & culture revitalization. It has online dictionaries with pronunciations for many BC First Nations languages.

Inner Body website. [www.innerbody.com](http://www.innerbody.com)

Students have the opportunity to interactively investigate the human anatomy.

*A Journey Into Time Immemorial*. Simon Fraser Museum of Archaeology and Ethnology, 2008. [www.sfu.museum/time/](http://www.sfu.museum/time/)

An interactive multimedia website based on the story of Xá:ytem Longhouse in Mission BC. Covers many aspects of Sto:lo culture including technology. For an accessible index to tool technology, go to [www.sfu.museum/time/en/sitemap/](http://www.sfu.museum/time/en/sitemap/)





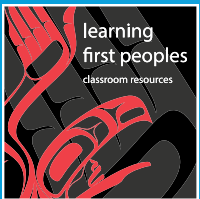

FIRST NATIONS EDUCATION STEERING COMMITTEE  
& FIRST NATIONS SCHOOLS ASSOCIATION  
113-100 PARK ROYAL SOUTH, WEST VANCOUVER, BC V7T 1A2  
[FNESC.CA/LEARNINGFIRSTPEOPLES](http://fnesc.ca/learningfirstpeoples)

